

# HarmoniXX

## Discover Engineering at its Best

- Numerous advances have been made in both performance and usability. In addition to precise motor control on all critical adjustable parts, the HarmoniXX series features a special walk-off compensation mechanism, designed for highest stability and an unprecedented level of wavelength optimization.

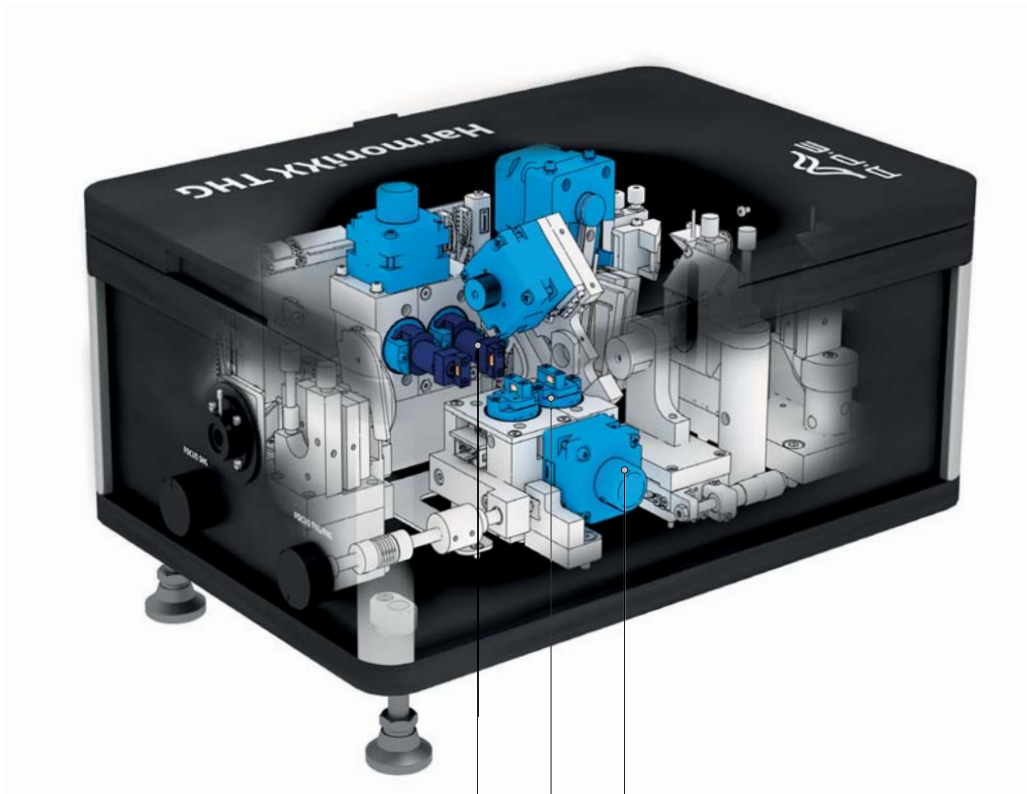

### More Wavelength and fs / ps Coverage

- **Quick Optics Exchange**

The right choice of non-linear crystals and other optical components is essential for high-quality wavelength conversion. A quick exchange of optics makes it possible to adapt the HarmoniXX to different laser parameters, providing more freedom in terms of wavelength coverage in femtosecond or picosecond operation.

### Easy, Intuitive, and Precise Operation

- **Motorization & Sensors**

All HarmoniXX wavelength tunable components are driven electro-mechanically for precise alignment. The combination of motorization and the power sensor option allows the user to optimize the output power at the press of a button. This ensures 100 % repeatability and consistently accurate alignment.

### Walk-off Compensation

- **Coupled Crystal Movement**

The special design of APE's coupled crystal movement compensates the beam walk-off in nonlinear crystals and therefore secures highest pointing stability. Whichever wavelength is used, you can be sure of optimum crystal parameters and conversion efficiency.

## ... Changing Wavelength Conversion

### Precise Motor Control is the New Standard

- The APE HarmoniXX series is now equipped with precise stepper motors to control all elements that require regular adjustment via the software GUI.
- This eliminates the need to open the device at all during alignment, which further improves the laser safety of the devices and keeps the optical elements free from contamination.
- APE offers the user all necessary tools for integration of the HarmoniXX into an automated laboratory setup.

### Wavelength Coverage in Flexible Design

- A flexible design, with a quick optics exchange for greater utility, allows the HarmoniXX to be configured for different laser types or alternative wavelength combinations and pulse durations. The quick-exchange optics are color-coded for a simple assignment of the different crystal types.

### Auto Power Optimization

- The HarmoniXX automatically optimizes all elements to maximum output power, even if the exact laser wavelength is unknown or changing. This feature is optionally available for all SHG, THG and FHG (2+2) HarmoniXX devices.

### Walk-off Compensation for Exceptional Performance

- The integrated walk-off compensation design ensures constant pointing stability and enables an enhanced conversion efficiency and beam quality while changing the wavelength of the HarmoniXX. The assembly set consists of entangled crystal movement compensators for a perfect crystal match in all experimental conditions.

# HarmoniXX Software

## HarmoniXX Software GUI

- The HarmoniXX software enables the user to control all relevant parameters through a software GUI on the PC and gives direct access to the motors.
- This software allows continuous tracking and automatic tuning of the wavelength when a spectrometer is connected.
- Integration into an automated laboratory setup is simple via the TCP/IP interface. Sample command sets are provided by APE.

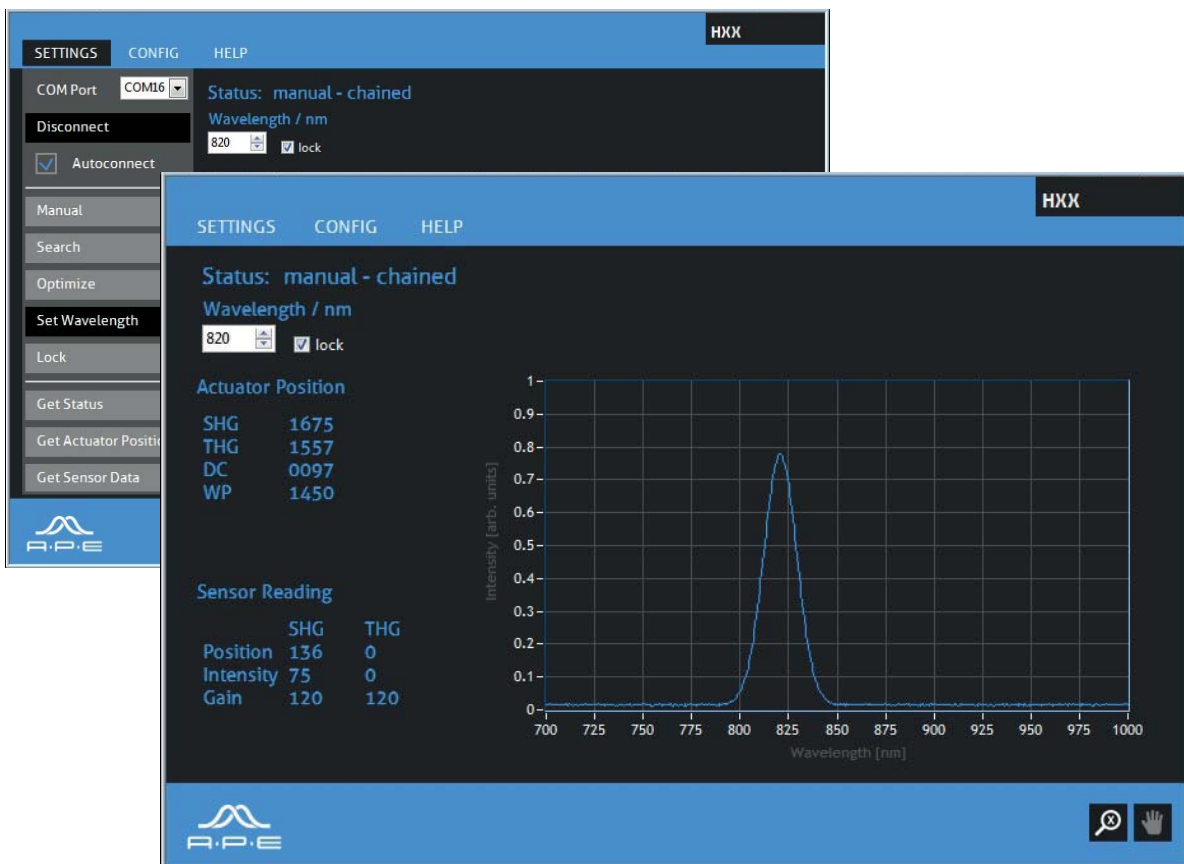

Software Interface

# HarmoniXX The Industry Standard

## Full Support for Industry Standards and Homebuilt Systems

- The well-established HarmoniXX family handles a wide variety of laser systems, pulse widths, and wavelengths from different manufacturers and homebuilt solutions.
- If your preferred system is not listed, contact us. We are always happy to help.

- Chameleon Coherent ■ Mira 900 Coherent
- Chameleon Compact OPO Coherent/APE ■ Mira OPO Coherent/APE ■ Discovery Coherent ■ Chameleon Vision Coherent ■ Chameleon Ultra ■ Fidelity Coherent ■ Paladin Advanced Coherent
- + Levante Emerald OPO Coherent/APE ■ RegA Coherent ■ Vitara Coherent ■ Inspire Spectra Physics
- Inspire OPO Spectra Physics ■ MaiTai Spectra Physics ■ Tsunami Spectra Physics ■ taccor tune Laser Quantum ■ Levante IR OPO APE ■ Levante Emerald OPO APE ■ picoEmerald APE ■ Emerald Engine APE ■ OPO-X APE ■ Goji Amplitude ■ Orange HP + Levante IR Menlo/APE ■ FemtoFiber ultra 1050 + Levante IR Toptica/APE ■ Aeropulse NKT



*If your preferred system should not be listed, you are welcome to make an inquiry.*

# HarmoniXX Specifications

## SHG

Input Wavelength Range	< 420 ... > 2000 nm (Spanning 1 Octave with one Optics Set; e.g. 650 - 1300 nm)
Output SHG	< 210 ... > 1000 nm (e.g. 340 ... 540 nm for TiSa)
Output Fundamental	Available
Pulse Duration	fs or ps
Conversion Efficiency	E.g. 40 % at 130 fs ; e.g. 15 % at 2 ps
Walkoff Compensation	Built-in mechanical walkoff compensator
Polarization (Linear)	Input: horizontal, SHG Out: vertical, Fundamental Out: horizontal
Automation	Fully Motorized, GUI / Software included, Auto Power Adjustment as Option

## THG

Input Wavelength Range	680 ... > 2000 nm (Spanning 1 Octave with one Optics Set; e.g. 650 - 1300 nm)
Output THG	Down to < 230 nm (e.g. 227 ... 360 nm for TiSa)
Output SHG	Available
Output Fundamental	Available
Pulse Duration	fs or ps
Conversion Efficiency	THG 10 % (fs), 3 % (ps)* SHG 20 % (fs), 10 % (ps)* *depends on laser model / pulse duration
Walkoff Compensation	Built-in mechanical walkoff compensator
Polarization (Linear)	Input: horizontal, THG Out: horizontal, SHG Out: vertical, Fundamental Out: vertical
Delay Compensation	Unlike conventional triplers, the HarmoniXX THG requires less adjustment efforts because no separation and recombination of the interacting beams is needed. This user-friendly feature has one common optical beam path for all interacting beams. It is implemented by means of a proprietary delay compensator and provides consistent spatial overlap for optimum efficiency.
Automation	Fully Motorized, GUI / Software included, Auto Power Adjustment as Option

## FHG 2+2

Input Wavelength Range	840 ... 920 nm (other wavelengths on request)
Output	Down to 210 nm (e.g. 210 ... 230 nm for TiSa)
Output SHG, Fundamental	Available
Pulse Duration	fs or ps
Conversion Efficiency	FHG 4 % (fs)* *depends on laser model / pulse duration
Walkoff Compensation	Built-in mechanical walkoff compensator
Polarization (Linear)	Input: horizontal, FHG Out: horizontal, SHG Out: vertical, Fundamental Out: horizontal
Automation	Fully Motorized, GUI / Software included, Auto Power Adjustment as Option

## ... Specifications

### FHG 3+1

Input Wavelength Range	760 ... 920 nm (other wavelengths on request)	
Output	Down to 190 nm (e.g. 190 ... 210 nm for TiSa)	
Output THG, SHG, Fundamental	Available	
Pulse Duration	fs or ps	
Conversion Efficiency	FHG < 0.1 % (fs)*	*depends on laser model / pulse duration
Polarization (Linear)	Input: horizontal, FHG Out: vertical, THG Out: horizontal, SHG Out: vertical, Fundamental Out: vertical	
Automation	On request	

### Options

Auto Power Adjustment	Automated output power optimization at the press of a button
Quick Exchangable Optics Set	Wavelength range exchange sets Pulse duration exchange set fs - ps

### SHG Power Pumped with Ti:Sapphire

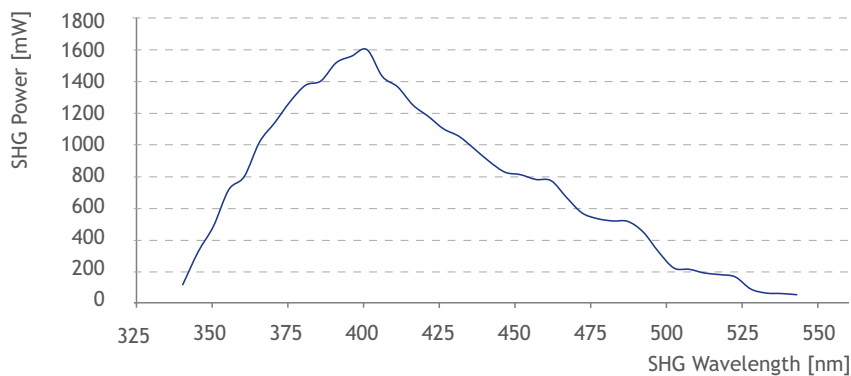

Typical tuning curve of HarmoniXX SHG power pumped with TiSa laser at about 3.5 W, 80 MHz, 130 fs.

### HarmoniXX THG, SHG in THG and FHG 2+2 Power Pumped with Ti:Sapphire

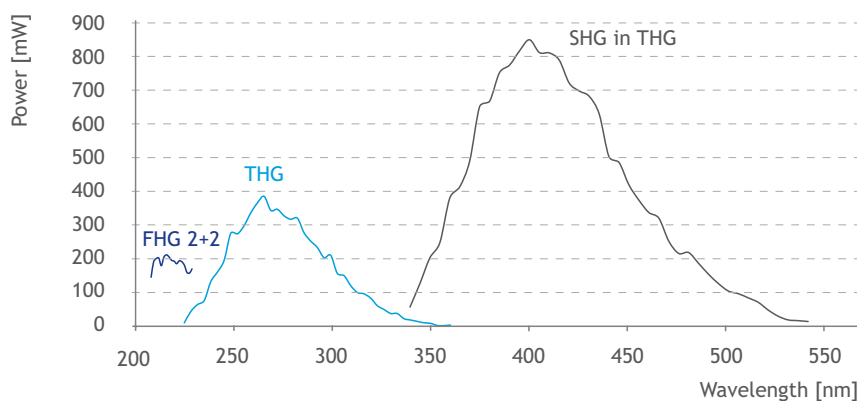

Typical tuning curves of HarmoniXX THG, SHG in THG and FHG 2+2 power pumped with TiSa laser at about 3.5 W, 80 MHz, 130 fs.

■ SHG / THG / FHG 2+2

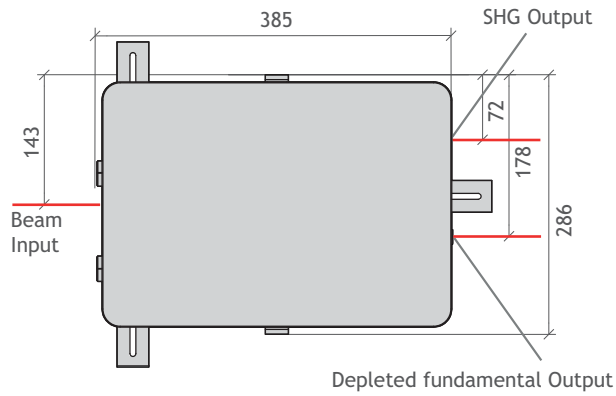

SHG / THG / FHG 2+2

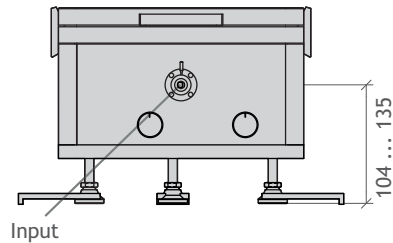

SHG

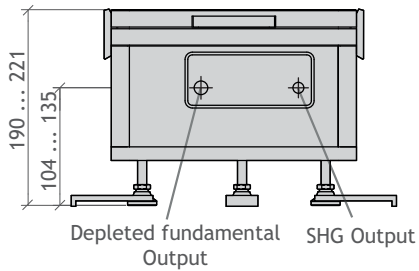

THG

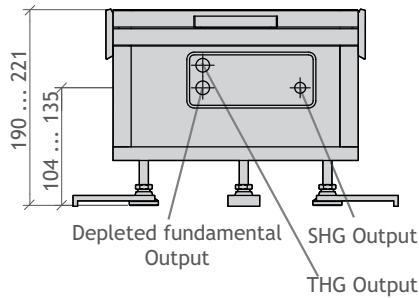

FHG 2+2

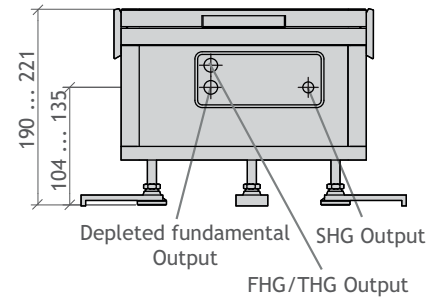

■ FHG 3+1

