

# Spatial Light Modulator – 1920 x 1200 **NEW**

E-Series: Educational, Economical & Entry-level

**Meadowlark Optics** is pleased to introduce our latest E-Series Spatial Light Modulator (SLM). Don't let the name fool you; with improved specifications over our previous model, it is anything but entry-level. It is, however, economical and ideally suited for educational labs with a limited budget. Liquid Crystal on Silicon (LCoS) Spatial Light Modulators (SLMs) are uniquely designed for pure phase applications and incorporate analog data addressing with high refresh rates. This combination provides users with the fastest response times and highest phase stabilities commercially available. Meadowlark offers both transmissive and reflective SLMs in either one- or two-dimensions. Phase-only SLMs can also be used for amplitude-only or a combination of both.

**High Phase Stability** - Meadowlark Optics is known for having the fastest SLMs with the least amount of phase ripple on the market. Our backplanes are custom designed with high refresh rates and direct analog drive schemes, resulting in phase ripple for standard products ranging between 0.10 – 0.30%. For customers who require even better performance, customization is possible with phase ripple as low as 0.025% (0.0008  $\pi$  radians). Phase ripple is quantified by measuring the variation in intensity of the 1<sup>st</sup> order diffracted spot as compared to the mean intensity while writing a blazed phase grating to the SLM.

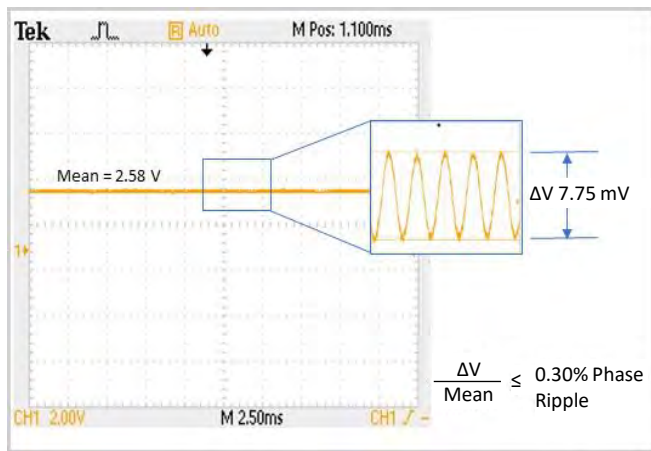

1<sup>st</sup> order Intensity when writing a phase ramp to the SLM

## Hardware Interface Options -

The 1920 x 1200 SLM is offered with a 60 Hz HDMI Controller enabling customers to take advantage of our fast liquid crystal response times. Standard hardware includes output trigger for synchronization.

### SLM Features

- • •
- High resolution
- High Phase Stability
- Pure analog phase control
- High first order efficiency
- High reflectivity
- High power handling
- Compact design
- Wavelengths from 400-1650 nm

### Software Features

- • •
- Output Trigger
- Image Generation
- Automated Sequencing
- Wavefront Calibration
- Global and Regional Look Up Tables



**Diffraction Efficiency (1st-order)** - This is the percentage of light measured in the 1st-order when writing a linear repeating phase ramp to the SLM as compared to the light in the 0<sup>th</sup> order when no pattern is written to the SLM. Diffraction efficiency varies as a function of the number of phase levels in the phase ramp. The plot to the right shows sample 1<sup>st</sup> order diffraction efficiency measurements, as a function of the phase ramp period, taken at various wavelengths.

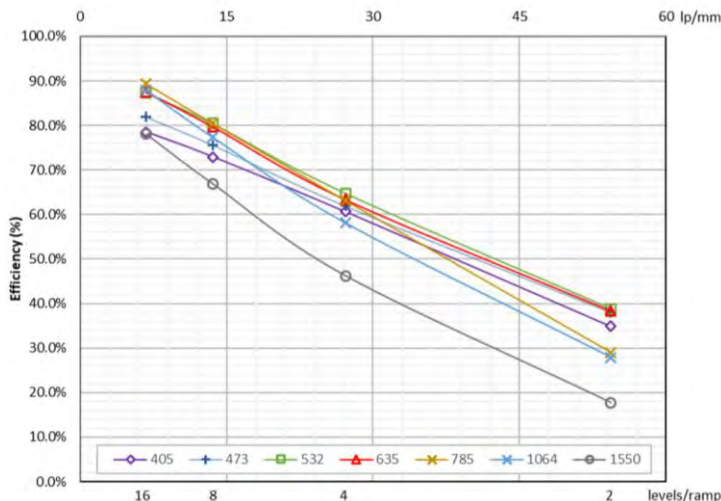

**Software** - Meadowlark Optics' SLMs are supplied with a Graphical User Interface and software development kits that support LabVIEW, Matlab, Python and C++. The software allows the user to generate images, to correct aberrations, to calibrate the global and/or regional optical response over 'n' waves of modulation, to sequence at a user defined frame rate, and to monitor the SLM temperature.

**Global or Regional Calibrations** - Regional calibrations provide the highest spatial phase fidelity commercially available by regionally characterizing the phase response to voltage and calibrating on a pixel-by-pixel basis.

**Image Generation Capabilities**

*Bessel Beams:* Spiral Phase, Fork, Concentric Rings, Axicons

*Lens Functions:* Cylindrical, Spherical

*Gratings:* Blazed, Sinusoid

*Diffraction Patterns:* Stripes, Checkerboard, Solid, Random Phase, Holograms, Zernike Polynomials, Superimpose Images

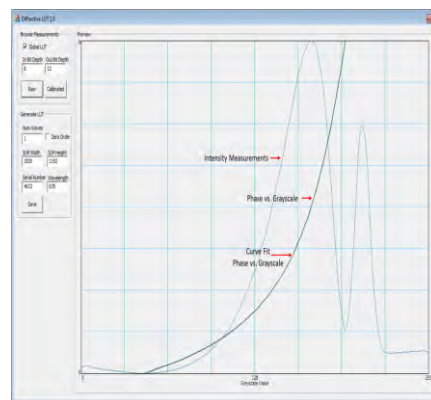
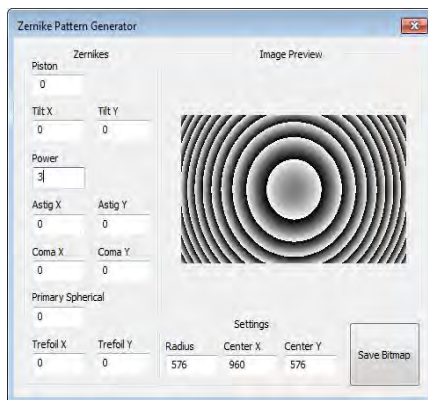
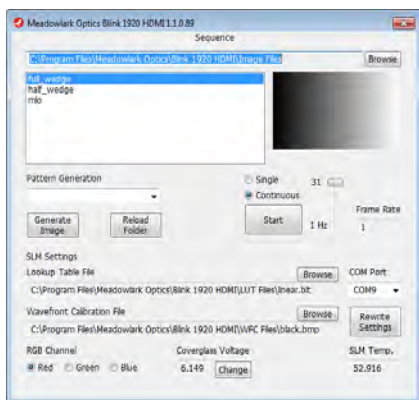
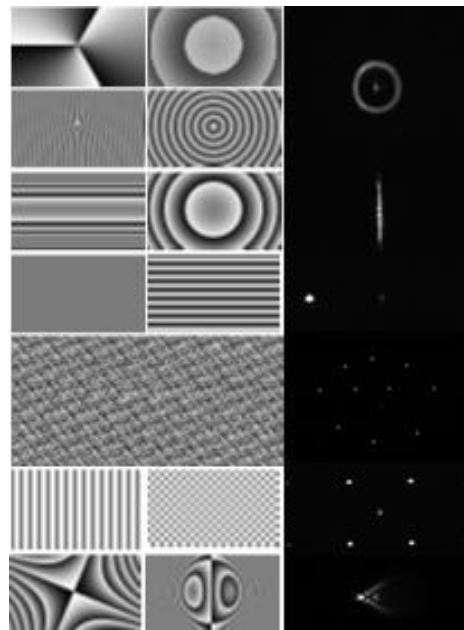



## 1920 x 1200 Analog Spatial Light Modulator Specifications

**Resolution:** 1920 x 1200

**Array Size:** 15.36 x 9.60 mm

**Phase Ripple:** 0.10 – 0.30% (custom as low as 0.025%)

**Fill Factor:** 95.6%

**Pixel Pitch:** 8.0 x 8.0  $\mu$ m

**Controller:** HDMI 8-bit

### Standard Speed System - Standard Liquid Crystal with HDMI Controller

Specify Calibration Wavelength	Wavefront Distortion	LC Response Time / System Frame Rate	AR Coatings (Ravg <1%)	0 <sup>th</sup> -order Diffraction Efficiency (varies with pixel value)	Reference this Model Number when Ordering
405 nm	$\lambda/3$	13.4 ms / 60 Hz	400 – 850 nm	83 – 90%	Model E19x12-400-700-HDMI
473 nm	$\lambda/4$	13.7 ms / 60 Hz	400 – 850 nm	84 – 90%	
532 nm	$\lambda/5$	14.0 ms / 60 Hz	400 – 850 nm	80 – 88%	
635 nm	$\lambda/6$	14.5 ms / 60 Hz	400 – 850 nm or 500 – 1200 nm	84 – 89%	Model E19x12-500-1200-HDMI
785 nm	$\lambda/7$	20.5 ms / 30 Hz	500 – 1200 nm	76 – 79%	
1064 nm	$\lambda/10$	25 ms / 30 Hz	500 – 1200 nm or 850 – 1650 nm	85 – 88%	Model E19x12-850-1650-HDMI
1550 nm	$\lambda/12$	45 ms / 15 Hz	850 – 1650 nm	85 – 91%	

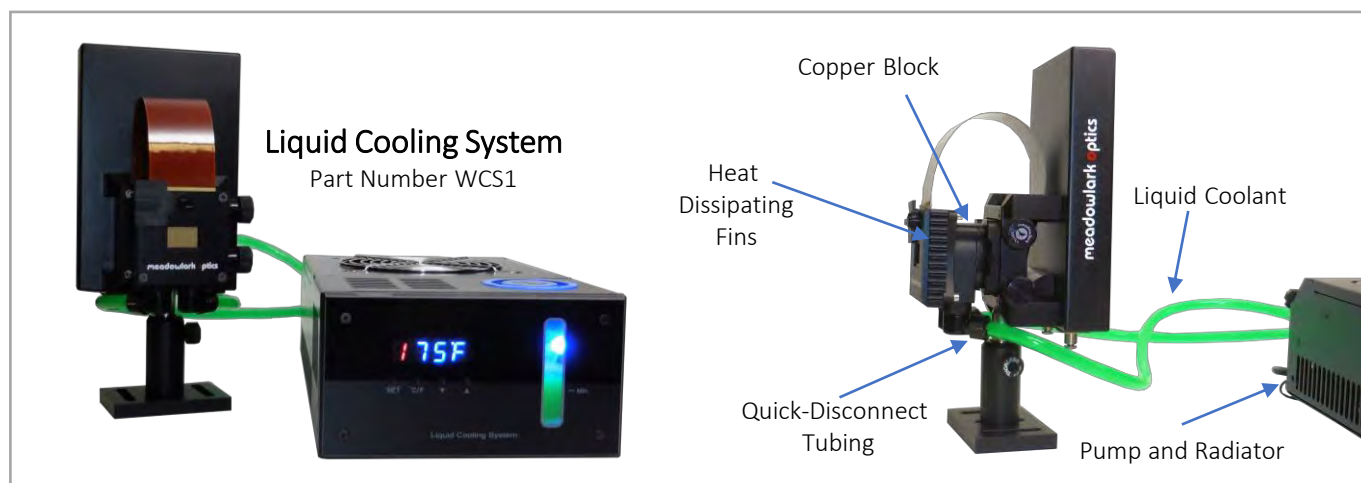

A copper block is attached to the back of the optical head to draw heat out of the SLM chip. The copper block is coupled via 2 meters of quick-disconnect tubing to cooling unit containing an external pump, radiator, and fan to cool the liquid down to ambient temperature. Includes one bottle of liquid coolant.



Depending on the application of the XY Phase Series SLM, many different optical setups can be used for either combined phase-amplitude mode or phase-only mode.

