

LightWire FF200

Compact
Femtosecond
Fiber Laser



FEATURES

- ▶ Pulse duration down to 130 fs
- ▶ Up to 200 mW output power
- ▶ Fiber delivery
- ▶ Compact, rugged design
- ▶ Low maintenance

APPLICATIONS

- ▶ Ultrafast spectroscopy
- ▶ Time-domain terahertz spectroscopy

LightWire FF200 is a cost effective turn-key femtosecond fiber laser with fiber delivery of the pulses all the way to your sample. Based on a well-established MOPA scheme,

LightWire FF200 model laser due to its all-in-fiber construction ensures a reliable hands free operation in very compact package.

OPTIONS

- ▶ Pulse picker option
[code: FF200-AOM]

PERFORMANCE

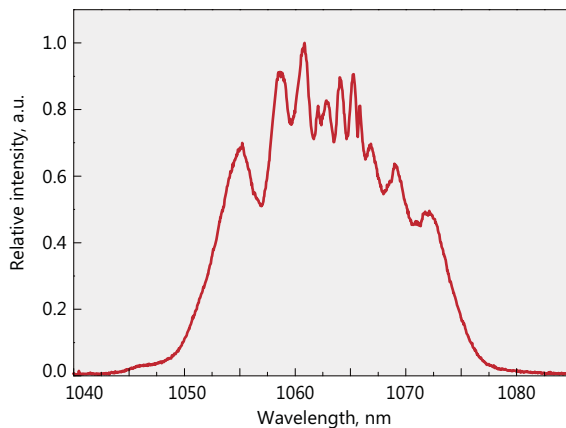

Typical spectrum from FF200 laser

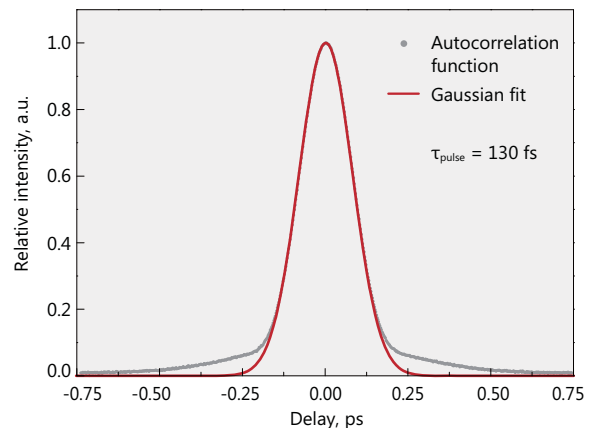

Typical autocorrelation from FF200 laser

SPECIFICATIONS ¹⁾

Model	LightWire FF200
Central wavelength	1064 nm
Compressed pulse duration	< 130 fs
Output power	> 200 mW
Oscillator pulse repetition rate	40 ± 2 MHz
Pulse repetition rate with pulse picker	20 kHz – 40 MHz (PRR = PRR _{osc} / N, N = 1, 4, 5, ..., 2000)
Pulse energy (without/with pulse picker)	> 5 nJ / > 2.5 nJ
Bandwidth (typical)	30 nm
Optical output	FC/PC connector ²⁾ or collimated beam (option)
Umbilical	1.5 m length armored cable Ø5 mm
Beam quality	M ² < 1.5
Pulse train monitoring	photodiode output for oscillator train, TTL synch pulse for laser output (with pulse picker option only)
Control interface	USB, CAN, RS232, LAN, (WLAN option)
Dimensions of control unit (L × W × H)	315 × 450 × 95 (stand alone) or 315 × 482 × 95 (19" rack mountable)
Dimensions of collimator unit (L × W × H)	164 × 73 × 75 mm
Weight	< 10 kg
Power supply	100–240 V, 50–60 Hz AC
Power consumption	maximal 230 W (typical 60 W)
Operating conditions	10–30 °C, humidity – not condensing



¹⁾ Due to continuous improvement all specifications are subject to change without notice.

²⁾ The connector is not suitable to connect with single mode fiber.

DRAWINGS

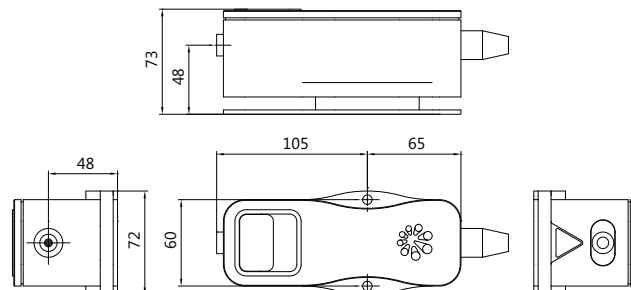
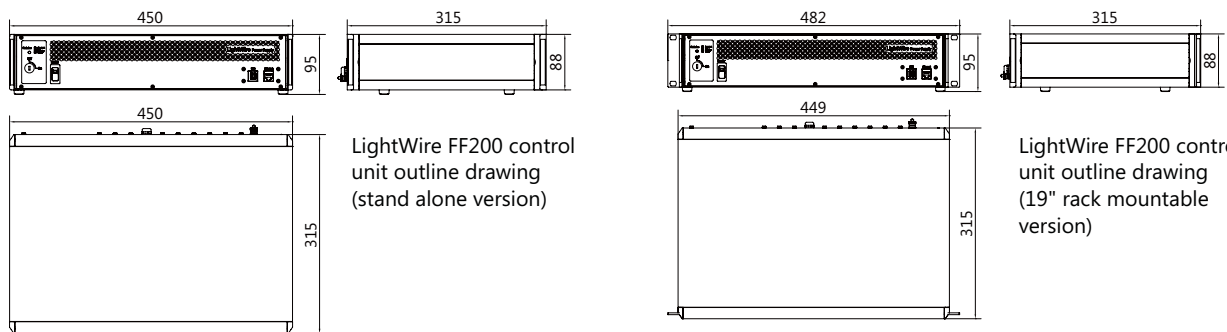

LightWire FF200 laser collimator unit outline drawing

All dimensions are in millimetres.