

# NL230 SERIES



## BENEFITS

- ▶ Short duration pulses (2 – 4 ns) ensures strong interaction with material and are highly suitable for LIBS
- ▶ User selectable wavelength single axis output is superior for experiments where alternating wavelengths are required such as material ablation and LIBS
- ▶ Rugged, monolithic design enables usage in harsh environments
- ▶ Diode pumped design provides quiet operation and eliminates flashlight irritation
- ▶ Variety of interfaces: USB, RS232, LAN and WiFi ensures easy control and integration with other equipment

The NL230 series diode-pumped Q-switched lasers produce up to 150 mJ at 100 Hz or up to 190 mJ at 50 Hz pulse repetition rate. Diode pumping allows maintenance-free laser operation for an extended period of time (more than 3 years for an estimated eight working hours per day). The typical pump diode lifetime is more than 1 billion shots.

Lasers are designed to produce high-intensity, high-brightness pulses and are targeted for applications such as LIBS, material ablation, remote sensing, OPO pumping. Due to an electro optical Q-switch, the master oscillator generates short duration pulses in the 2–4 ns range. The oscillator cavity optical design

features a variable reflectivity output coupler, giving a low-divergence laser beam.

A closed-loop air-cooled chiller is used for laser cooling, eliminating the need for external cooling water and reducing running costs.

Angle-tuned non-linear crystals mounted in temperature stabilized heaters are used for optional second or third harmonic generation. The harmonic separation system is designed to ensure radiation with a high spectral purity and to direct it to the separate output ports.

For customer convenience the laser can be controlled via a remote control pad or PC. The remote pad allows easy control of all parameters

## High Energy Q-switched DPSS Nd:YAG Lasers

### FEATURES

- ▶ Diode-pumped
- ▶ Rugged sealed laser cavity
- ▶ Up to **190 mJ** at **1064 nm** pulse energy
- ▶ Up to **100 Hz** pulse repetition rate
- ▶ Short pulse duration in the **2–4 ns** range
- ▶ Variable reflectivity output coupler for low-divergence beam
- ▶ Quiet operation: no more flashlamp firing sound
- ▶ Remote control via keypad and/or PC with supplied LabVIEW™ drivers
- ▶ Optional temperature-stabilized second and third harmonic generators

### APPLICATIONS

- ▶ LIBS (Light Induced Breakdown Spectroscopy)
- ▶ Material ablation
- ▶ OPO pumping
- ▶ Remote Sensing
- ▶ LIDAR (Light Detection And Ranging)
- ▶ Mass Spectroscopy
- ▶ LIF (Light Induced Fluorescence)

and features a backlit display that is easy to read even through laser safety eyewear. Alternatively, the laser can be controlled from a personal computer via supplied Windows™ compatible software. LabVIEW™ drivers are also included with each laser installation package.

SPECIFICATIONS <sup>1)</sup>

Model	NL231-50	NL231-100
Pulse energy (not less than) <sup>2)</sup>		
at 1064 nm	190 mJ	150 mJ
at 532 nm <sup>3)</sup>	110 mJ	90 mJ
at 355 nm <sup>4)</sup>	55 mJ	40 mJ
Pulse energy stability (StdDev) <sup>5)</sup>		
at 1064 nm	< 1 %	
at 532 nm	< 2.5 %	
at 355 nm	< 3.5 %	
Pulse repetition rate	50 Hz	100 Hz
Power drift <sup>6)</sup>	< ±1 %	
Pulse duration <sup>7)</sup>	2 – 4 ns	
Linewidth	< 1 cm <sup>-1</sup> at 1064 nm	
Beam profile <sup>8)</sup>	"Top Hat" in near field and close to Gaussian in far field	
Beam divergence <sup>9)</sup>	< 0.8 mrad	
Beam pointing stability (StDev) <sup>10)</sup>	≤ 60 μrad	
Polarization	linear, > 95 % at 1064 nm	
Typical beam diameter <sup>11)</sup>	5 mm	
Optical pulse jitter (StDev)		
Internal triggering regime <sup>12)</sup>	< 0.5 ns	
External triggering regime <sup>13)</sup>	< 0.5 ns	
SYNC OUT pulse delay	-100 ms ... 100 ms	
Typical warm-up time	10 min	
<b>PHYSICAL CHARACTERISTICS</b>		
Laser head size (W × L × H)	251 × 291 × 167 ± 3 mm	
Power supply unit (W × L × H)		
Desktop case	471 × 391 × 147 mm ± 3 mm	
19" module	483 × 355 × 133 mm ± 3 mm	
External chiller	inquire	
Umbilical length	2.5 m	
<b>OPERATING REQUIREMENTS</b>		
Cooling (air cooled) <sup>14)</sup>	external chiller	
Ambient temperature	18–27 °C	
Relative humidity (non-condensing)	20–80 %	
Power requirements	100–240 V AC, single phase, 50/60 Hz	
Power consumption	< 1.0 kVA	

<sup>1)</sup> Due to continuous improvement, all specifications are subject to change. The parameters marked typical may vary with each unit we manufacture. Unless stated otherwise all specifications are measured at 1064 nm and for basic system without options.

<sup>2)</sup> Outputs are not simultaneous. Inquire for higher energy (up to 350 mJ at 50 Hz, 250 mJ at 100 Hz) custom models.

<sup>3)</sup> With H230SHC or H230STHC harmonic generator module.

<sup>4)</sup> With H230THC or H230STHC generator modules.

<sup>5)</sup> Averaged from pulses, emitted during 30 sec time interval.

<sup>6)</sup> Measured over 8 hours period after 20 min warm-up when ambient temperature variation is less than ± 2 °C.

<sup>7)</sup> FWHM.

<sup>8)</sup> Near field (at the output aperture) TOP HAT fit is >80%.

<sup>9)</sup> Full angle measured at the 1/e<sup>2</sup> level.

<sup>10)</sup> Beam pointing stability is evaluated as movement of the beam centroid in the focal plane of a focusing element.

<sup>11)</sup> Beam diameter is measured at 1064 nm at the 1/e<sup>2</sup> level.

<sup>12)</sup> With respect to SYNC OUT pulse.

<sup>13)</sup> With respect to QSW IN pulse.

<sup>14)</sup> Adequate room air conditioning should be provided.

**Notes:** The laser and auxiliary units must be settled in such a place void of dust and aerosols. It is advisable to operate the laser in air conditioned room, provided that the laser is placed at a distance from air conditioning outlets. The laser should be positioned on a solid worktable. Access from one side should be ensured. Intensive sources of vibration should be avoided near the laboratory (ex. railway station or similar).



PERFORMANCE

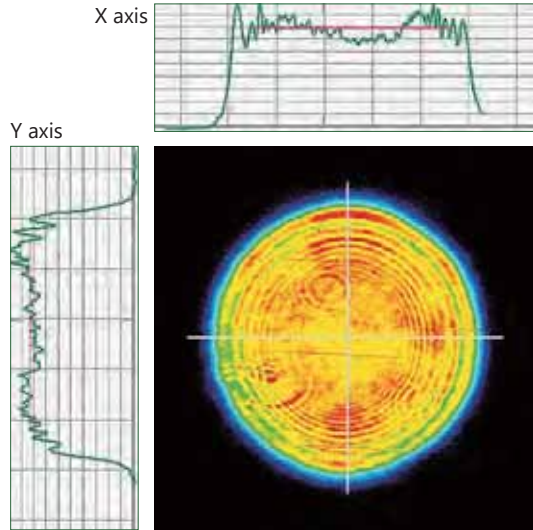

Fig 1. NL230 laser typical near field beam profile

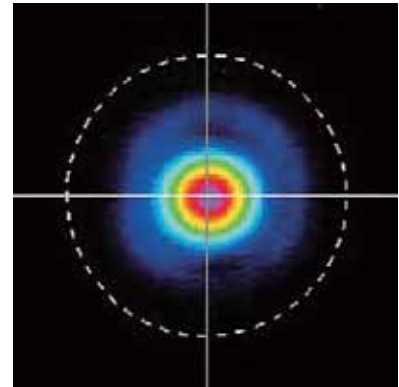

Fig 2. NL230 laser typical far field beam profile

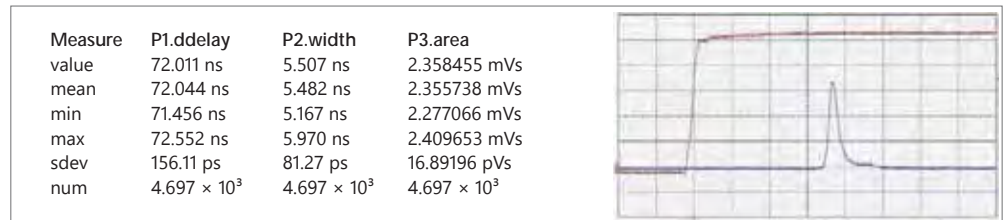

Fig 3. NL230 laser pulse waveform

OUTLINE DRAWINGS

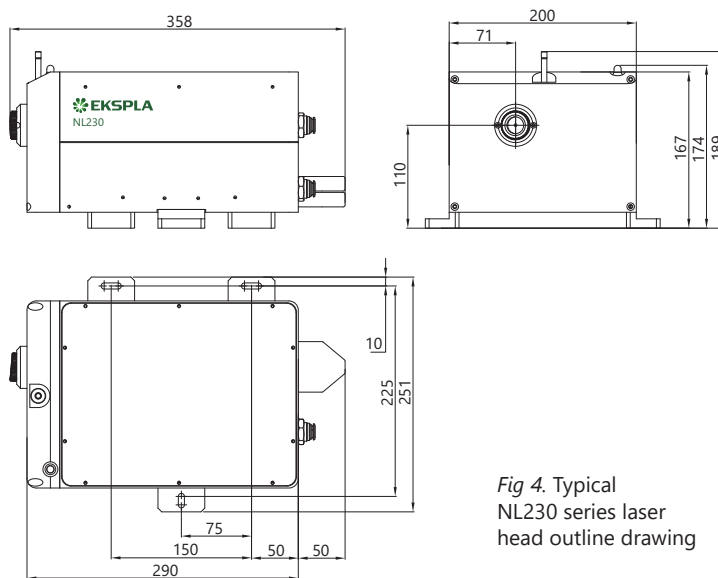
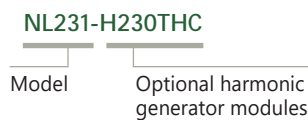

Fig 4. Typical NL230 series laser head outline drawing

ORDERING INFORMATION



Note: Laser must be connected to the mains electricity all the time. If there will be no mains electricity for longer than 1 hour then laser (system) needs warm up for a few hours before switching on.

# NL740 SERIES



## Ultra-stable Nanosecond Laser

### FEATURES

- ▶ Narrow bandwidth, **stable**, true SLM pulses
- ▶ Excellent pulse energy (typically 0.1 % StDev @ 1064 nm) and pulse duration stability
- ▶ Excellent spatial mode stability
- ▶ Excellent output power stability (typically <math>\pm 0.5\%</math> peak-to-peak)
- ▶ **3 – 10 ns tunable** pulse duration
- ▶ Up to **100 mJ** output energy
- ▶ Up to **100 Hz** repetition rate
- ▶ 1064, 532 nm or 355 nm output wavelength
- ▶ Reliable 24/7 operation

### BENEFITS

- ▶ Stable SLM pulses make the NL740 suitable for metrology (LIDT), interferometry, holography and DIAL (LIDAR) applications
- ▶ Excellent pulse energy and spatial and temporal mode stability ensure high quality experiment statistical data and saves on the cost and time spent for tests and investigation
- ▶ High repetition rate (up to 100 Hz) ensures fast acquisition of experiment data
- ▶ 3 – 10 ns tunable pulse duration enables experiments using a wide range of durations; no need to purchase separate lasers for experiments requiring different pulse duration
- ▶ Reliable 24/7 operation is excellent for metrology, especially Laser-Induced Damage Threshold (LIDT) applications
- ▶ Variety of interfaces: USB, RS232, LAN and WiFi ensures easy integration with other equipment

### APPLICATIONS

- ▶ Metrology, especially Laser-Induced Damage Threshold (LIDT)
- ▶ Front end for power amplifiers
- ▶ Interferometry and holography
- ▶ Material processing and others

The main feature of NL740 series is the output of ultra-stable tunable duration (2 – 10 ns) narrow bandwidth nanosecond pulses based on temporally driven CW diode laser seeder and amplification stages.

Start of the system is the single mode DFB laser with temporal output power modulator. Such front-end ensures reliable generation of SLM mode that is highly beneficial for formation of low temporal modulation ultra-stable pulses. Then light is amplified in diode pumped regenerative amplifier in order to

reach energy sufficient to amplify in diode pumped amplifiers. Power amplifier is a chain of double pass amplifiers where pulse is amplified up to 100 mJ energy at 100 Hz repetition rate. Before amplification spatial beam shaping is employed in order to get flat top shape at the output. The harmonic generators are based on angle tuned nonlinear crystals placed in a heater. All diode pumped design ensures reliable operation of system at high repetition rates as well as simple and convenient maintenance.

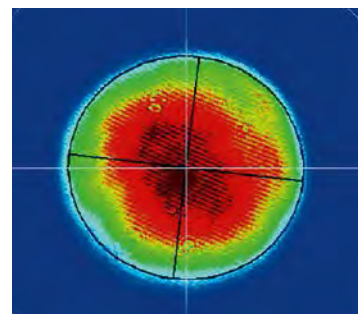

Fig 1. Typical NL740 near field beam profile at 532 nm

SPECIFICATIONS <sup>1)</sup>

Model	NL740	NL742
Pulse energy (for 5 ns pulse <sup>5)</sup> )		
at 1064 nm	2 mJ	100 mJ
at 532 nm <sup>2)</sup>	NA	50 mJ
at 355 nm <sup>2)</sup>	NA	30 mJ
Pulse energy stability (StdDev) <sup>3)</sup>		
at 1064 nm		< 0.5 %
at 532 nm		< 1.0 %
at 355 nm		< 1.5 %
Power drift <sup>4)</sup>		± 2 %
Pulse duration <sup>5)</sup>		3 – 10 ns
Repetition rate		100 Hz
Polarization at 1064 nm		vertical, > 98 %
Optical pulse jitter <sup>6)</sup>		< 150 ps
Linewidth		<0.1 cm <sup>-1</sup>
Beam profile	Gaussian	Top-Hat (at laser output), without diffraction rings
Typical beam diameter <sup>7)</sup>	~2 mm	~5 mm
Beam divergence <sup>8)</sup>	1.0 mrad	0.7 mrad
Beam pointing stability (StdDev)		< 30 μrad

PHYSICAL CHARACTERISTICS		
Laser head (W × L × H)	456 × 1031 × 249 mm	600 × 1200 × 330 mm
Power supply unit (W × L × H)	85 × 170 × 41 mm	520 × 500 × 210 mm
Umbilical length	2.5 m ( other length on request )	

OPERATING REQUIREMENTS		
Cooling	air-cooled	air-cooled chiller
Ambient temperature	stabilized; from range 18–25 °C	
Relative humidity	20–80 % (non-condensing)	
Power requirements <sup>9)</sup>	100–240 V AC, single phase 50/60 Hz	
Power consumption	< 200 W	< 1.5 kW

- <sup>1)</sup> Due to continuous improvement, all specifications are subject to change. Parameters marked typical are illustrative; they are indications of typical performance and will vary with each unit we manufacture. Unless stated otherwise, all specifications are measured at 1064 nm and for basic system without options.
- <sup>2)</sup> Harmonic outputs are not simultaneous; only single wavelength beam is present at the output at once. Manual reconfiguration is required to switch wavelength.
- <sup>3)</sup> Standard deviation value averaged from pulses, emitted during 30 sec time interval after 20 minutes of warm-up.
- <sup>4)</sup> Deviation from average value measured over 8 hours of operation when room temperature variation is less than ±2 °C.

- <sup>5)</sup> FWHM. Measured with photodiode with 100 ps rise time and oscilloscope with 600 MHz bandwidth.
- <sup>6)</sup> Standard deviation value, measured with respect to triggering pulse.
- <sup>7)</sup> Beam diameter is measured at 1064 nm at laser output at the 1/e<sup>2</sup> level.
- <sup>8)</sup> Full angle measured at the 1/e<sup>2</sup> level at 1064 nm.
- <sup>9)</sup> Mains voltage should be specified when ordering.



PERFORMANCE

**Note:** Laser must be connected to the mains electricity all the time. If there will be no mains electricity for longer than 1 hour then laser (system) needs warm up for a few hours before switching on.

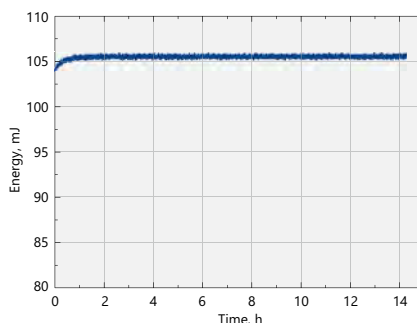

Fig 2. Typical NL740 long-term energy stability

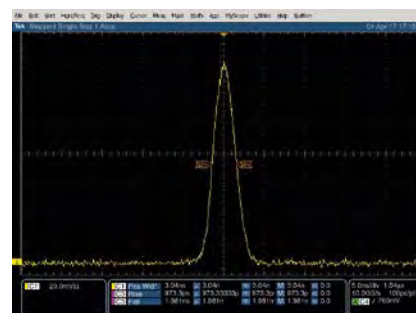

Fig 3. Typical NL740 pulse shape