

# PGx01 SERIES



Travelling Wave Optical Parametric Generators (TWOPG) are an excellent choice for researchers who need an ultra-fast tunable coherent light source from UV to mid IR.

## Design

The units can be divided into several functional modules:

- ▶ optical parametric generator (OPG);
- ▶ diffraction grating based linewidth narrowing system (LNS);
- ▶ optical parametric amplifier (OPA);
- ▶ electronic control unit.

The purpose of the OPG module is to generate parametric superfluorescence (PS). Spectral properties of the PS are determined by the properties of a nonlinear crystal and usually vary with the generated wavelength. In order to produce narrowband radiation, the output from OPG is narrowed by LNS down to  $6 \text{ cm}^{-1}$  and then used to seed OPA.

Output wavelength tuning is achieved by changing the angle of the nonlinear crystal(s) and grating. To ensure exceptional wavelength reproducibility, computerized control unit driven precise stepper motors rotate the nonlinear crystals and diffraction grating. Nonlinear crystal

temperature stabilization ensures long-term stability of the output radiation wavelength.

In order to protect nonlinear crystals from damage, the pump pulse energy is monitored by built-in photodetectors, and the control unit produces an alert signal when pump pulse energy exceeds the preset value.

For customer convenience the laser can be operated from master device or personal computer through USB (VCP, ASCII commands), RS232 (ASCII commands), LAN (REST API) or RS232 (ASCII commands), LAN (REST API) depending on the system configuration or from remote control pad with backlit display that is easy to read even while wearing laser safety glasses.

## Available models

Model	Features
PG401	Model has a tuning range from 420 to 2300 nm and is optimized for providing highest pulse energy in the visible part of the spectrum. The wide tuning range makes PG401 units suitable for many spectroscopy application.
PG501-DFG	Model has a tuning range from 2300 to 16000 nm. The PG501-DFG1 model is the optimal choice for vibrational-SFG spectroscopy setups.

## High Energy Broadly Tunable OPA

### FEATURES

- ▶ Ultra-wide spectral range from **193 to 16000 nm**
- ▶ High peak power (**>50 MW**) ideal for non-linear spectroscopy applications
- ▶ Narrow linewidth **<6  $\text{cm}^{-1}$**  (for UV <  $9 \text{ cm}^{-1}$ )
- ▶ Motorized hands-free tuning in 193–2300 nm or 2300–16000 nm range
- ▶ PC control
- ▶ Remote control via keypad

### APPLICATIONS

- ▶ Nonlinear spectroscopy: vibrational-SFG, surface-SH, Z-scan
- ▶ Pump-probe experiments
- ▶ Laser-induced fluorescence (LIF)
- ▶ Other laser spectroscopy applications

**SPECIFICATIONS <sup>1)</sup>**

Model	PG401	PG401-SH	PG401-DUV	PG501-DFG1	PG501-DFG2
<b>Tuning range</b>					
DUV	-		193–209.95 nm	-	
SH	-	210–340, 370–419 nm	-		
Signal	420 – 680 nm	-			
Idler	740 – 2300 nm	-			
DFG				2300–10000 nm	2300–16000 nm
Output pulse energy <sup>2)</sup>	> 1000 µJ at 450 nm	> 100 µJ at 300 nm	> 50 µJ at 200 nm	> 250 µJ at 3700 nm, > 40 µJ at 10000 nm	> 250 µJ at 3700 nm, > 80 µJ at 10000 nm
Linewidth	< 6 cm <sup>-1</sup>	< 9 cm <sup>-1</sup>		< 6 cm <sup>-1</sup>	
Max pulse repetition rate	50 Hz				
<b>Scanning step</b>					
Signal	0.1 nm	-			
Idler	1 nm	-			
Typical beam size <sup>3)</sup>	~4 mm	~3 mm		~9 mm	
Beam divergence <sup>4)</sup>	< 2 mrad			-	
Beam polarization	-	vertical		horizontal	
Signal	horizontal	-			
Idler	horizontal	-			
Typical pulse duration	~20 ps	~15 ps		~20 ps	

**PUMP LASER REQUIREMENTS**

<b>Pump energy</b>					
at 355 nm	10 mJ			-	
at 532 nm	-			10 mJ	
at 1064 nm	-	2 mJ	6 mJ	15 mJ	
Recommended pump source <sup>5)</sup>	PL2231-50-TH, PL2251A-TH		PL2231-50-TH, PL2251A-TH	PL2231A-50-SH, PL2251B-SH	
Beam divergence	< 0.5 mrad				
Beam profile	homogeneous, without hot spots, Gaussian fit >90 %				
Pulse duration <sup>6)</sup>	29 ± 4 ps				

**PHYSICAL CHARACTERISTICS**

Size (W x L x H)	456 × 633 × 244 mm	456 × 1031 × 249 ± 3 mm			
------------------	-----------------------	-------------------------	--	--	--

**OPERATING REQUIREMENTS**

Room temperature	15 – 30 °C				
Power requirements	100 – 240 V AC single phase, 47 – 63 Hz				
Power consumption	< 100 W				

<sup>1)</sup> Due to continuous improvement, all specifications are subject to change without notice. Parameters marked typical are not specifications. They are indications of typical performance and will vary with each unit we manufacture. Unless stated otherwise, all specifications are measured at 450 nm for PG401 units, 3000 nm for PG501 units and 300 nm for PG401SH units and for basic system without options.

<sup>2)</sup> See tuning curves for typical pulse energies at other wavelengths. Higher energies are available, please contact Ekspla for more details.

<sup>3)</sup> Beam diameter is measured at the 1/e<sup>2</sup> level.

<sup>4)</sup> Full angle measured at the FWHM point.

<sup>5)</sup> If a pump laser other than PL2250 or PL2230 is used, measured beam profile data should be presented when ordering.

<sup>6)</sup> Should be specified if non-EKSPLA pump laser is used.



**CUSTOMIZED FOR SPECIFIC REQUIREMENTS**

Please note that these products are custom solutions tailored for specific applications or specific requirements.

**Interested?** Tell us more about your needs and we will be happy to provide you with tailored solution.

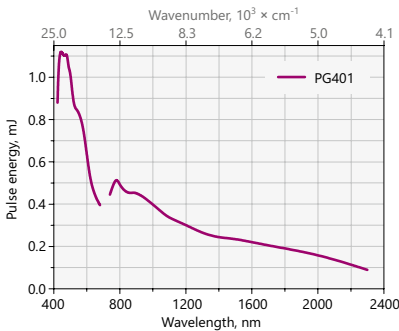
**PG401-DFG1 provides:**

- ▶ The broadest hands-free tuning range – from 420 to 10000 nm
- ▶ It can be further extended up to 16000 nm with -DFG2 option. It should be noted, that for the 8000 – 16000 nm range a different nonlinear crystal is used, and exchange of the crystals needs to be done manually

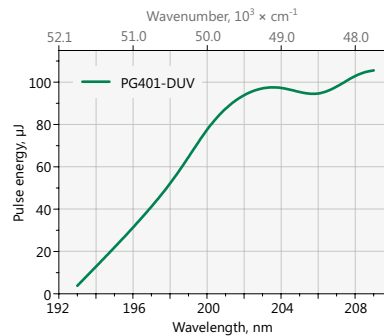
**PG402 features:**

- ▶ Gap-free tuning range 410 – 709, 710 – 2300 nm
- ▶ Linewidth < 18 cm<sup>-1</sup>

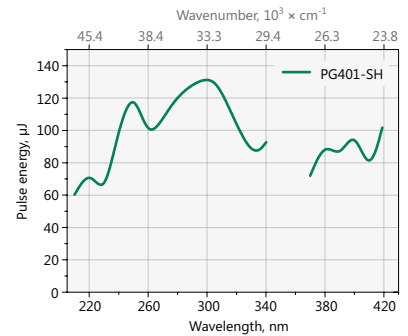
**TUNING CURVES**



*Fig 1. Typical PG401 model tuning curve  
Pump energy: 10 mJ at 355 nm*

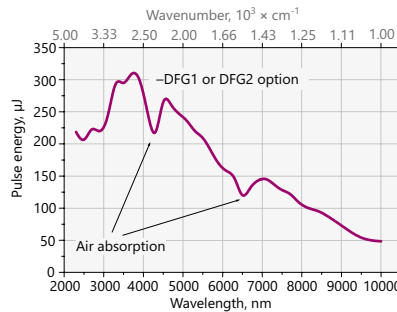


*Fig 2. Typical PG401-DUV model tuning curve*

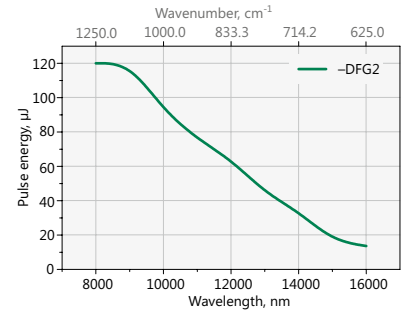


*Fig 3. Typical PG401-SH model tuning curve. Pump energy: 10 mJ at 355 nm*

*Note: The energy tuning curves are affected by air absorption due narrow linewidth. These pictures present pulse energies where air absorption is negligible.*

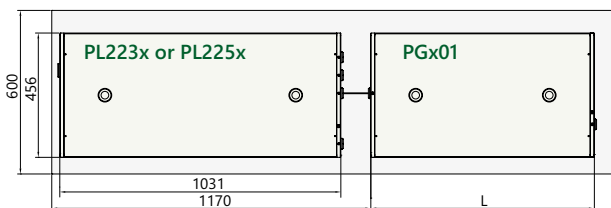


*Fig 4. Typical PG501-DFG1 tuning curve in 2300–10000 nm range  
Pump energy: 7 mJ at 1064 nm*

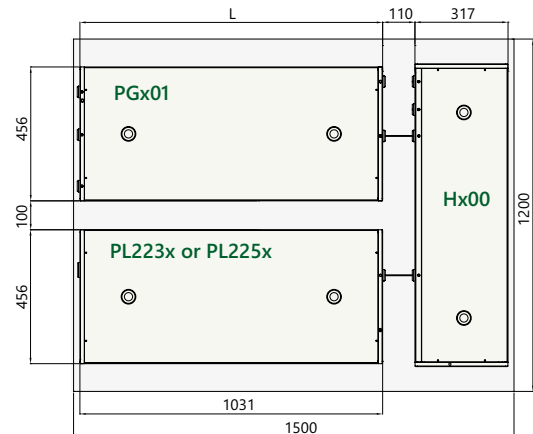


*Fig 5. Typical PG501-DFG2 tuning curve in 8000–16000 nm range  
Pump energy: 15 mJ at 1064 nm*

**RECOMMENDED UNITS ARRANGEMENT ON OPTICAL TABLE**



*Fig 6. Arrangement of pump laser and PGx01 unit on optical table*



*Fig 7. Recommended arrangement of pump laser and PGx01-DFGx unit on optical table*

OUTLINE DRAWINGS

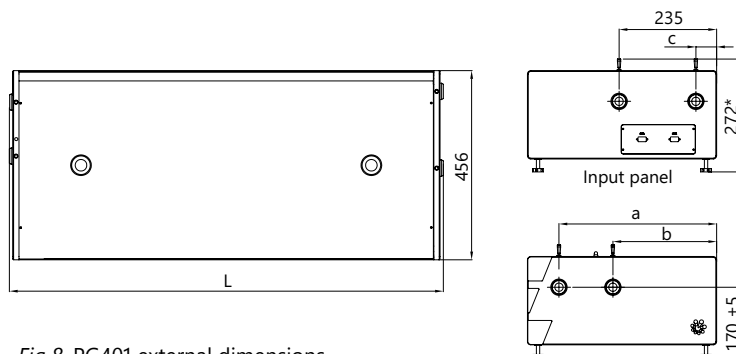
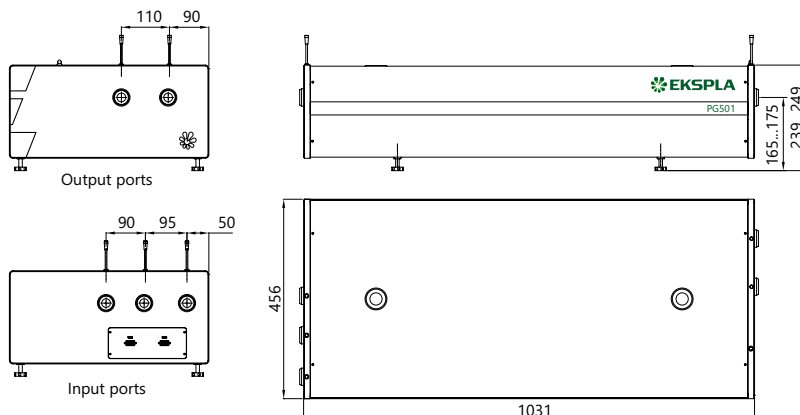


Fig 8. PG401 external dimensions

OUTPUTS PORTS

Model	L, mm	a, mm	b, mm	c, mm	Port 1	Port 2
PG401	633	380	x	x	420–680 nm, 740–2300 nm	–
PG401-SH	838	380	x	x	210–340 nm, 370–419.9 nm, 420–680 nm, 740–2300 nm	–
PG401-SH/DUV	1026	380	250	50	210–340 nm, 370–419 nm, 420–680 nm, 740–2300 nm	192–209.95 nm



For SFG optional 532 nm output port 2.

Fig 9. PG501 external dimensions

ORDERING INFORMATION

**PG401-DUV**

Model  
PG4xx → 355 nm pump

01 → travelling wave, narrowed linewidth  
02 → travelling wave, not narrowed  
11 → synchronous pumping, narrowed

Optional tuning range extension  
DUV → 193–209.95 nm  
SH → 210–340 nm & 370–420 nm

*Custom products, tailored for specific applications. Inquire for other specifications.*

DFG1 → 2300–10000 nm; >250 μJ at 3700 nm  
DFG2 → 2300–16000 nm

**PG501-DFG1**

Model  
PG5xx → 532 nm pump

01 → travelling wave, narrowed linewidth

Tuning range  
DFG1 → 2300–10000 nm; >250 μJ at 3700 nm  
DFG2 → 2300–16000 nm

**Note:** Laser must be connected to the mains electricity all the time. If there will be no mains electricity for longer than 1 hour then laser (system) needs warm up for a few hours before switching on.