

# NT340 SERIES

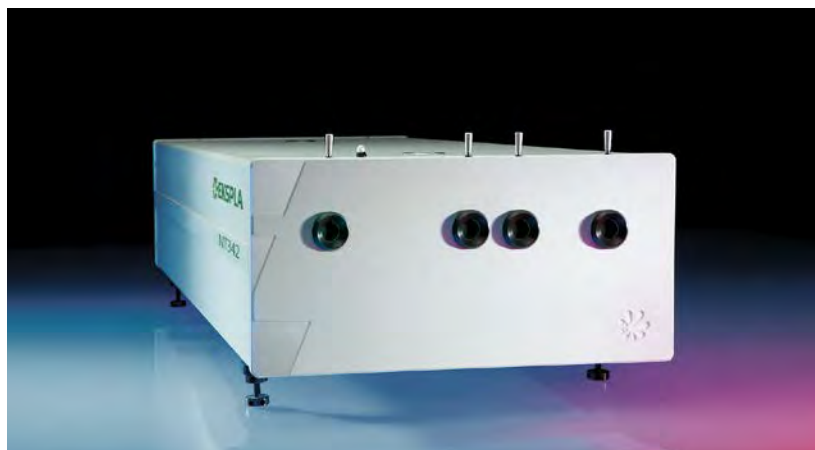

## BENEFITS

- ▶ The system is widely tunable 192 – 2600 nm and delivers high pulse energy (up to 60 mJ) that allows the investigation of an extensive range of materials
- ▶ Up to 18  $\mu\text{m}$  customization possibility enables studies of IR vibrations of molecules
- ▶ Narrow linewidth (down to 3  $\text{cm}^{-1}$ ) and superior tuning resolution (1 – 2  $\text{cm}^{-1}$ ) allows recording of high quality spectra
- ▶ Flashlamps replacement without misalignment of the laser cavity saves on maintenance costs
- ▶ High integration level saves valuable space in the laboratory
- ▶ In-house design and manufacturing of complete systems, including pump lasers, guarantees on-time warranty and post warranty services and spares supply
- ▶ Variety of control interfaces: USB, RS232 and optional LAN, WLAN ensures easy control and integration with other equipment
- ▶ Attenuator and fiber coupling options facilitate incorporation of NT340 systems into various experimental environments

The NT340 series tunable wavelength nanosecond laser seamlessly integrates the nanosecond optical parametric oscillator and the Nd:YAG Q-switched nanosecond laser – all in a compact housing.

The main system features are: hands-free wavelength tuning from UV to IR, high conversion efficiency, optional fiber-coupled output and separate output port for pump laser beam.

NT340 has a linewidth of less than 5  $\text{cm}^{-1}$ , which is ideal for many spectroscopic applications.

The laser is designed for convenient use. It can be controlled from remote keypad or PC using LabView™ drivers that are supplied with the system. The remote keypad features a backlit display that is easy to read even through laser safety goggles. The OPO pump energy monitoring system helps to control pump laser parameters. Replacement of laser flashlamps can be done without misalignment of the laser cavity and/or deterioration of laser performance.

## High Energy Broadly Tunable Lasers

### FEATURES

- ▶ Hands-free no gap wavelength tuning from **192 to 4400 nm**
- ▶ Up to **60 mJ** pulse energy in visible spectral range
- ▶ Up to **10 mJ** pulse energy in UV spectral range
- ▶ Up to **15 mJ** pulse energy in MIR spectral range
- ▶ **3 – 5 ns** pulse duration
- ▶ Up to **20 Hz** pulse repetition rate
- ▶ Remote control via key pad or PC
- ▶ Optional separate shared output port for 532/1064 nm beam (separate output port for the 355 nm beam is standard)
- ▶ OPO pump energy monitoring
- ▶ Hermetically sealed oscillator cavity protects non-linear crystals from dust and humidity

### APPLICATIONS

- ▶ Laser-induced fluorescence
- ▶ Flash photolysis
- ▶ Photobiology
- ▶ Remote sensing
- ▶ Time-resolved spectroscopy
- ▶ Non-linear spectroscopy
- ▶ Vibrational spectroscopy
- ▶ Cavity ring-down CRDS, cavity ring-down laser absorption CRLAS spectroscopy
- ▶ Infrared spectroscopy
- ▶ Gas spectroscopy

**Tuning range extending optional add-ons**

Option	Features
-SH	Second harmonic generator for 210–410 nm range
-SF	Sum-frequency generator for 300–410 nm range with high pulse energy
-SH/SF	Combined option for highest pulse energy in 210–410 nm range
-DUV	Deep UV option for 192–210 nm range output
-MIR	Mid infrared option for 2500–4400 nm range output

**Accessories and other optional add-ons**

Option	Features
-FC	Fiber coupled output in 350–2000 nm range
-ATTN	Attenuator
-H, -2H	Separate shared output port for pump laser harmonic (532 or 1064 nm wavelengths)
-AW	Air cooled power supply

**SPECIFICATIONS <sup>1)</sup>**

Model	NT342B	NT342C
<b>OPO</b>		
Wavelength range <sup>2)</sup>		
Signal	410–710 nm <sup>3)</sup>	
Idler	710–2600 nm	
SH generator (optional)	210–410 nm	
SH/SF generator (optional)	210–410 nm	
DUV generator (optional)	192–210 nm	
MIR generator (optional)	2500–4400 nm	
Output pulse energy		
OPO <sup>4)</sup>	30 mJ	60 mJ
SH generator (optional) <sup>5)</sup>	4 mJ	6.5 mJ
SH/SF generator (optional) <sup>6)</sup>	6 mJ	10 mJ
DUV generator (optional) <sup>7)</sup>	0.6 mJ	1 mJ
MIR generator (optional) <sup>8)</sup>	15 mJ	
Linewidth	< 5 cm <sup>-1</sup> <sup>9)</sup>	
Tuning resolution <sup>10)</sup>		
Signal (410–710 nm)	1 cm <sup>-1</sup>	
Idler (710–2600 nm)	1 cm <sup>-1</sup>	
SH/SF/DUV (192–410 nm)	2 cm <sup>-1</sup>	
MIR (2500–4400 nm)	1 cm <sup>-1</sup>	
Pulse duration <sup>11)</sup>	3–5 ns	
Typical beam diameter <sup>12)</sup>	5 mm	7 mm
Typical beam divergence <sup>13)</sup>	< 2 mrad	
Polarization		
Signal	horizontal	
Idler	vertical	
SH/SF	horizontal	
DUV	vertical	
MIR	horizontal	

SPECIFICATIONS <sup>1)</sup>

Model	NT342B	NT342C
<b>PUMP LASER <sup>14)</sup></b>		
Pump wavelength	355 nm	
Typical pump pulse energy	100 mJ	150 mJ
Pulse duration	4–7 ns	
Beam quality	Hat-top in near field, without hot spots	
Beam divergence	< 0.6 mrad	
Pulse energy stability (StdDev)	< 3.5 %	
Pulse repetition rate	10 or 20 Hz	10 Hz
<b>PHYSICAL CHARACTERISTICS</b>		
Unit size (W × L × H) <sup>15)</sup>	456 × 821 × 270 mm	
Power supply size (W × L × H)	330 × 490 × 585 mm	
Umbilical length	2.5 m	
<b>OPERATING REQUIREMENTS</b>		
Water consumption (max 20 °C) <sup>16)</sup>	< 10 l/min	
Room temperature	18–27 °C	
Relative humidity	20–80 % (non-condensing)	
Power requirements	200 – 240 VAC, single phase, 50/60 Hz	
Power consumption	< 1.5 kVA	
Cleanliness of the room	not worse than ISO Class 9	

<sup>1)</sup> Due to continuous improvement, all specifications are subject to change. Parameters marked typical are illustrative; they are indications of typical performance and will vary with each unit we manufacture. Unless stated otherwise, all specifications are measured at 450 nm and for basic system without options.

<sup>2)</sup> Hands-free tuning range is from 192 nm to 4400 nm. MIR option is not compatible with SF and DUV option. Inquire for custom IR option with tuning up to 18 μm.

<sup>3)</sup> Tuning range extension to 400 – 709 nm is optional.

<sup>4)</sup> Measured at 450 nm. See tuning curves for typical outputs at other wavelengths.

<sup>5)</sup> Measured at 260 nm. See tuning curves for typical outputs at other wavelengths.

<sup>6)</sup> Measured at 340 nm. SF generator is optimized for maximum output in 300 – 410 nm range. See tuning curves for typical outputs at other wavelengths.

<sup>7)</sup> Measured at 200 nm. See tuning curves for typical outputs at other wavelengths.

<sup>8)</sup> Measured at 3000 nm. See tuning curves for typical outputs at other wavelengths.

<sup>9)</sup> Linewidth is <8 cm<sup>-1</sup> for 210–409 nm, 2500–4400 nm ranges.

<sup>10)</sup> When wavelength is controlled from PC. When wavelength is controlled from keypad, tuning resolution is 0.1 nm for signal, 1 nm for idler, MIR and 0.05 nm for SH, SF and DUV.

<sup>11)</sup> FWHM measured with photodiode featuring 1 ns rise time and 300 MHz bandwidth oscilloscope.

<sup>12)</sup> Beam diameter is measured at 450 nm at the FWHM level. It is approximate and can vary depending on the pump pulse energy and wavelength.

<sup>13)</sup> Full angle measured at the FWHM level at 450 nm, < 5 mrad at 3000 nm with MIR option.

<sup>14)</sup> Separate output port for the 355 nm beam is standard. Outputs for 1064 nm and 532 nm beams are optional. Laser output will be optimised for the best OPO operation and specifications may vary with each unit we manufacture.

<sup>15)</sup> Length from 821 to 1220 mm depending on configuration.

<sup>16)</sup> Air cooled power supply is available as an option.

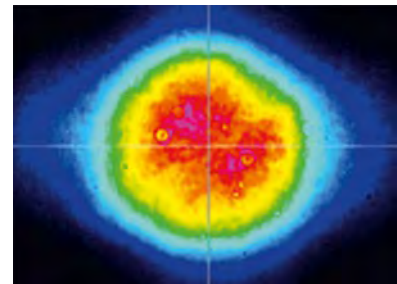

Fig 1. NT340 series laser typical beam profile at 450 nm after ~1.5 m distance from output

PERFORMANCE

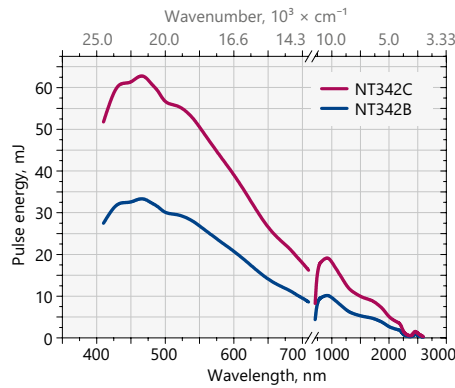

Fig 2. Typical output energy of the NT340 series tunable wavelength systems

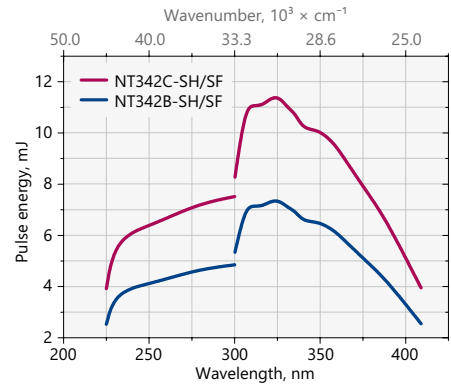

Fig 3. Typical output energy of the NT340 series tunable wavelength systems with SH/SF extension

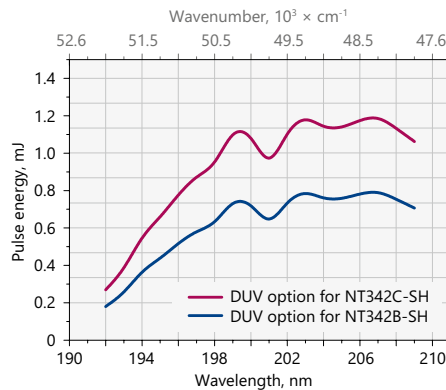

Fig 4. Typical output energy of the NT340 series tunable wavelength systems with SH/DUV extension

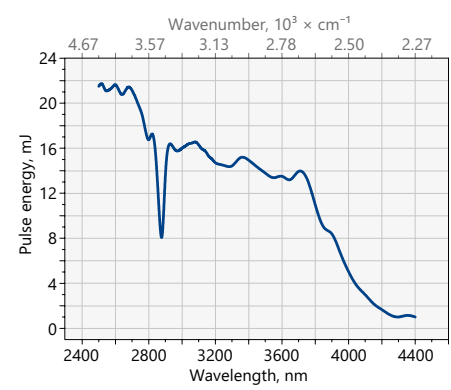

Fig 5. Typical output energy of the NT340 series tunable wavelength systems with MIR extension

OUTLINE DRAWINGS

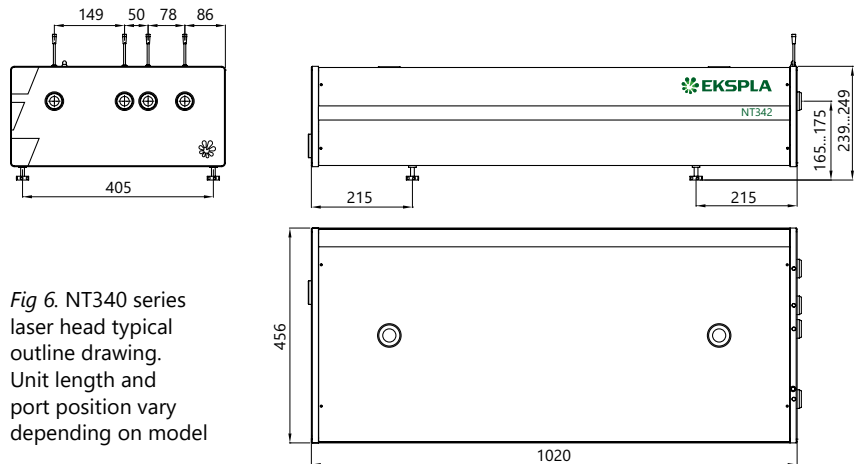

Fig 6. NT340 series laser head typical outline drawing. Unit length and port position vary depending on model

ORDERING INFORMATION

**Note:** Laser must be connected to the mains electricity all the time. If there will be no mains electricity for longer than 1 hour then laser (system) needs warm up for a few hours before switching on.

**NT342B-SH-10-AW-H/2H**

Model	Pulse repetition rate, in Hz	Options:
Output pulse energy: B → 30 mJ C → 50 mJ	Optional tuning range extension SH → 210–410 nm DUV → 192–210 nm MIR → 2500–4400 nm	AW → water-air heat exchanger H → 1064 nm output 2H → 532 nm output

# NT350 SERIES



## BENEFITS

- ▶ High pulse energy (up to 230 mJ) is highly beneficial for photoacoustics imaging applications
- ▶ Superior tuning resolution ( $1 - 2 \text{ cm}^{-1}$ ) allows recording of high quality spectra
- ▶ High integration level saves valuable space in the laboratory
- ▶ Flashlamps replacement without misalignment of the laser cavity saves on maintenance costs
- ▶ In-house design and manufacturing of complete systems, including pump lasers, guarantees on-time warranty and post warranty services and spares supply
- ▶ Variety of control interfaces: USB, RS232, optional LAN and WLAN ensures easy control and integration with other equipment
- ▶ Attenuator and fiber bundle coupling options facilitate incorporation of NT350 systems into various experimental environments

NT352 series tunable laser seamlessly integrates in a compact housing a nanosecond optical parametric oscillator and Nd:YAG Q-switched laser.

Two models with different output pulse energy values are offered. The most powerful model has more than 230 mJ pulse energy at 700 nm. Narrow linewidth ( $<10 \text{ cm}^{-1}$ ) is nearly constant through whole tuning range, which makes laser suitable for many spectroscopy application.

The device is controlled from the remote keypad or PC using LabVIEW™ drivers that are supplied with the system. The remote pad features a backlit display that is easy to read even while wearing laser safety glasses.

System is designed for easy and cost-effective maintenance. Replacement of flashlamps can be done without misalignment of the laser cavity and deterioration of laser performance. OPO pump energy monitoring system helps to increase lifetime of the optical components.

## High Energy NIR Range Tunable Lasers

### FEATURES

- ▶ Hands-free, automated wavelength tuning from **330 to 2600 nm**
- ▶ Up to **230 mJ** in range 660 – 2600 nm, **35 mJ** in range 330 – 660 nm
- ▶ Narrow linewidth across tuning range
- ▶ **3–5 ns** pulse duration
- ▶ Remote control via key pad or PC
- ▶ Separate output port for 532 nm beam. Output for 1064 nm is optional
- ▶ OPO pump energy monitoring
- ▶ Hermetically sealed oscillator cavity protects non-linear crystals from dust and humidity

### APPLICATIONS

- ▶ Photoacoustic imaging
- ▶ Flash photolysis
- ▶ Photobiology
- ▶ Remote sensing
- ▶ Non-linear spectroscopy

### Options

Optional items are available allowing optimization of the laser system for your application, for example:

- ▶ Fiber bundle coupled output;
- ▶ Energy meter;
- ▶ Efficient second harmonic generator for 330–660 nm range;
- ▶ Pulse energy attenuator;
- ▶ Water-air cooled power supply.

Please inquire custom-build versions and options.

**SPECIFICATIONS <sup>1)</sup>**

Model	NT352C	NT352E
<b>OPO</b>		
Wavelength range		
Signal	660–1064 nm	
Idler	1065–2600 nm	
SH	330–660 nm	
Output pulse energy <sup>2)</sup>		
OPO	150 mJ	230 mJ
SH	25 mJ	35 mJ
Linewidth <sup>3)</sup>		
<10 cm <sup>-1</sup>		
Tuning resolution <sup>4)</sup>		
Signal (660–1064 nm)	1 cm <sup>-1</sup>	
Idler (1064–2450 nm)	1 cm <sup>-1</sup>	
SH (330–530 nm)	2 cm <sup>-1</sup>	
Pulse duration <sup>5)</sup>		
3–5 ns		
Typical beam diameter <sup>6)</sup>		
	7 mm	9 mm
Typical beam divergence <sup>7)</sup>		
<2 mrad		
Polarization		
Signal beam	horizontal	
Idler beam	vertical	
SH beam	vertical	
<b>PUMP LASER <sup>8)</sup></b>		
Pump wavelength		
532 nm		
Typical pump pulse energy		
	450 mJ	700 mJ
Pulse duration		
4 – 7 ns		
Beam quality		
"Hat-Top" in near field. Close to Gaussian in far field		
Beam divergence		
<0.6 mrad		
Pulse energy stability (StdDev)		
<2.5 %		
Pulse repetition rate		
10 Hz		
<b>PHYSICAL CHARACTERISTICS</b>		
Unit size (W × L × H)		
456 × 821 × 270 mm		
Power supply size (W × L × H)		
330 × 490 × 585 mm		
Umbilical length		
2.5 m		
<b>OPERATING REQUIREMENTS</b>		
Water consumption (max 20 °C) <sup>9)</sup>		
<10 l/min		
Room temperature		
18–27 °C		
Relative humidity		
20–80 % (non-condensing)		
Power requirements <sup>10)</sup>		
200 – 240 VAC, single phase, 50/60 Hz		
Power consumption		
< 1.5 kW		
Cleanliness of the room		
not worse than ISO Class 9		

<sup>1)</sup> Due to continuous improvement, all specifications are subject to change without notice. The parameters marked typical are not specifications. They are indications of typical performance and will vary with each unit we manufacture. Unless stated otherwise all specifications are measured at 700 nm and for basic system without options.

<sup>2)</sup> Measured at 700 nm for OPO and 350 nm for SH. See tuning curves for typical outputs at other wavelengths.

<sup>3)</sup> In signal and idler range.

<sup>4)</sup> When wavelength is controlled from PC. When wavelength is controlled from keypad, tuning resolution is 0.1 nm for signal, 1 nm for idler and 0.5 nm for SH.

<sup>5)</sup> FWHM measured with photodiode featuring 1 ns rise time and 300 MHz bandwidth oscilloscope.

<sup>6)</sup> Beam diameter is measured at 700 nm at the 1/e<sup>2</sup> level and can vary depending on the pump pulse energy.

<sup>7)</sup> Full angle measured at the FWHM level at 700 nm.

<sup>8)</sup> Separate output port for the 532 nm beam is standard. Output for 1064 nm beam is optional. Pump laser output will be optimized for the best OPO operation and specification may vary with each unit we manufacture.

<sup>9)</sup> Air cooled power supply is available as option.

<sup>10)</sup> Mains voltage should be specified when ordering.



PERFORMANCE

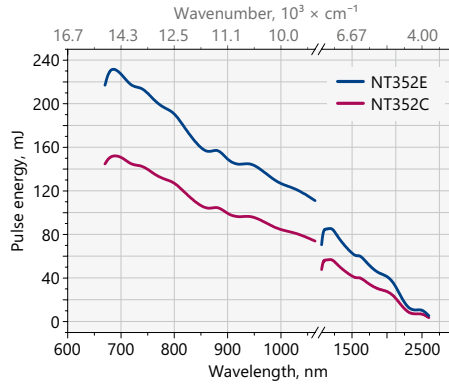

Fig 1. Typical output energy of the NT350 series tunable wavelength systems

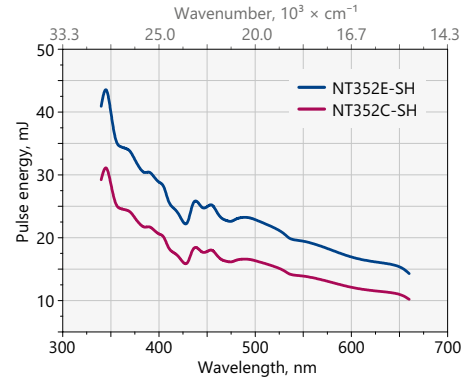

Fig 2. Typical output energy of the NT350 series tunable wavelength systems with SH option

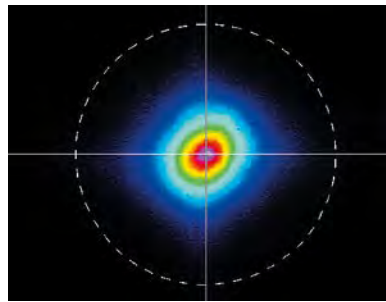
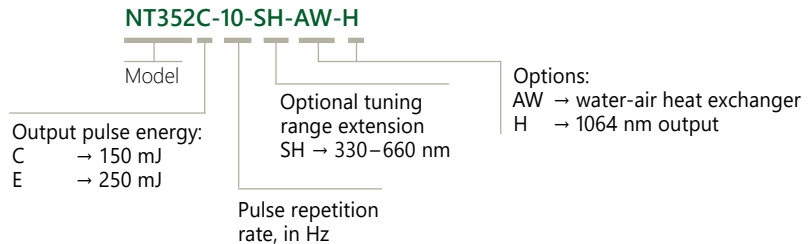

Fig 3. Typical far field beam profile of NT352B laser at 800 nm

ORDERING INFORMATION

**Note:** Laser must be connected to the mains electricity all the time. If there will be no mains electricity for longer than 1 hour then laser (system) needs warm up for a few hours before switching on.



**PHOTO TECHNICA** [www.phototechnica.co.jp](http://www.phototechnica.co.jp)  
 フォトテクニカ株式会社

〒336-0017 埼玉県さいたま市南区南浦和 1-2-17  
 TEL:048-871-0067 FAX:048-871-0068  
 e-mail:voc@phototechnica.co.jp

# NT370 SERIES

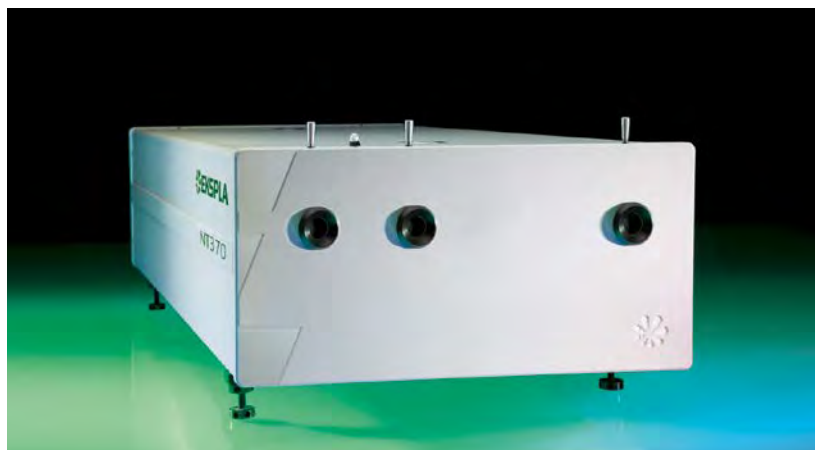

## BENEFITS

- ▶ Wide tuning range in 2500 – 4400 nm or 5500 – 18 000 nm is highly useful for s-SNOM and other IR applications
- ▶ NT370 is a cost effective solution covering a wide tuning range from a single source
- ▶ Superior tuning resolution ( $1 \text{ cm}^{-1}$ ) allows recording of high quality spectra
- ▶ High integration level saves on valuable space in the laboratory
- ▶ Flashlamps replacement without misalignment of the laser cavity saves on maintenance costs
- ▶ In-house design and manufacturing of complete systems, including pump lasers, guarantees on-time warranty and post warranty services and spares supply
- ▶ Variety of control interfaces: USB, RS232, optional LAN and WLAN ensures easy control and integration with other equipment

NT370 series tunable laser seamlessly integrates in a compact housing the nanosecond optical parametric oscillator and Nd:YAG Q-switched laser. Pumped by fundamental harmonics output the laser provides tuning in mid- and far-infrared spectral ranges.

NT373-XIR model uses IR crystal based cascade OPO for tunable output in 5500–18000 nm range. Customized tuning ranges are available upon request. The linewidth of NT373-XIR model is nearly constant across tuning range and it is less than  $8 \text{ cm}^{-1}$ .

NT377 model produces tunable output in 2500–4400 nm range. Pulse energy is exceeding 10 mJ for wavelengths shorter than 3600 nm, while linewidth is below  $8 \text{ cm}^{-1}$ . Because of narrow linewidth of output radiation the laser is suitable for many infrared spectroscopic applications, for example cavity ring-down spectroscopy, gas detection and remote sensing.

The device is controlled from the remote keypad or from PC using LabView™ drivers that are supplied together with the system. The remote pad features a backlit display that is easy to read even while wearing laser

## High Energy IR Range Tunable Lasers

### FEATURES

- ▶ Hands-free, automated wavelength tuning
- ▶ Up to **15 mJ** pulse energy in mid and **1 mJ** in far IR spectral range
- ▶ Less than  **$8 \text{ cm}^{-1}$**  linewidth
- ▶ **3 – 5 ns** pulse duration
- ▶ **10 or 20 Hz** pulse repetition rate
- ▶ Remote control via key pad or PC
- ▶ Separate output port for 1064 nm pump beam option
- ▶ OPO pump energy monitoring
- ▶ Replacement of the flashlamps without misalignment of the laser cavity

### APPLICATIONS

- ▶ Vibrational spectroscopy
- ▶ Cavity ring-down CRDS, cavity ring-down laser absorption CRLAS spectroscopy
- ▶ Infrared spectroscopy
- ▶ Gas spectroscopy

safety glasses. System is designed for easy and cost-effective maintenance. Replacement of flashlamps can be done without misalignment of the laser cavity and deterioration of laser performance. OPO pump energy monitoring system helps to increase lifetime of the optical components.

### Accessories and optional add-ons

Option	Features
-AW	Water-air cooling option
-20	20 Hz PRR option
-H	Optional 1064 nm output



**SPECIFICATIONS** <sup>1)</sup>

Model	NT377	NT373-XIR
<b>OPO</b>		
Wavelength range	2 500–4 400 nm	5 500–18 000 nm <sup>2)</sup>
Output pulse energy <sup>3)</sup>	15 mJ	1 mJ
Linewidth <sup>4)</sup>	< 8 cm <sup>-1</sup>	
Tuning resolution <sup>5)</sup>	1 cm <sup>-1</sup>	
Typical pulse duration <sup>6)</sup>	3–5 ns	
Typical beam diameter <sup>7)</sup>	8 mm	10 mm
Polarization	horizontal	
<b>PUMP LASER</b> <sup>8)</sup>		
Pump wavelength	1064 nm	
Typical pump pulse energy	250 mJ	300 mJ
Pulse duration	4–7 ns	
Beam quality	"Hat-Top" in near field	
Beam divergence	< 0.5 mrad	
Pulse energy stability (StdDev)	< 1 %	
Pulse repetition rate	10 or 20 Hz	
<b>PHYSICAL CHARACTERISTICS</b>		
Unit size (W × L × H)	456 × 820 × 274 mm	456 × 1030 × 274 mm
Power supply size (W × L × H)	330 × 490 × 585 mm	
Umbilical length	2.5 m	
<b>OPERATING REQUIREMENTS</b>		
Water consumption (max 20 °C) <sup>9)</sup>	<10 l/min	
Room temperature	18–27 °C	
Relative humidity	20–80 % (non-condensing)	
Power requirements <sup>10)</sup>	200 – 240 VAC, single phase, 50/60 Hz	
Power consumption	< 1.5 kVA	
Cleanliness of the room	not worse than ISO Class 9	

<sup>1)</sup> Due to continuous improvement, all specifications are subject to change without notice. Parameters marked typical are not specifications. They are indications of typical performance and will vary with each unit we manufacture. Unless stated otherwise all specifications are measured at 3000 nm for NT377 unit and at 7000 nm for NT373-XIR unit and for basic system without options.

<sup>2)</sup> Additional output in 1780 – 2010 nm and 2300 – 2645 nm ranges is possible. Please contact Ekspla for more detailed specifications.

<sup>3)</sup> Output is specified at wavelengths defined in note 1. See tuning curves for typical outputs at other wavelengths.

<sup>4)</sup> Linewidth is specified at wavelengths defined in note 1.

<sup>5)</sup> When wavelength is controlled from PC. When wavelength is controlled from keypad, tuning resolution is 1 nm

<sup>6)</sup> Measured art FWHM level with photodiode featuring 1 ns rise time and 300 MHz bandwidth oscilloscope.

<sup>7)</sup> Beam diameter is measured at the 1/e<sup>2</sup> level and varies depending on the wavelength.

<sup>8)</sup> Laser output will be optimized for the best OPO operation and specification may vary with each unit we manufacture.

<sup>9)</sup> Air cooled power supply is available as an option.

<sup>10)</sup> Should be specified when ordering.



**PERFORMANCE**

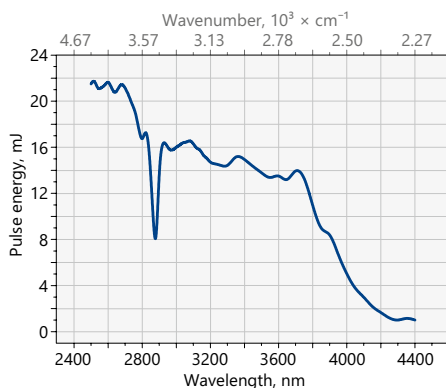

Fig 1. Typical output energy of the NT377 tunable wavelength laser

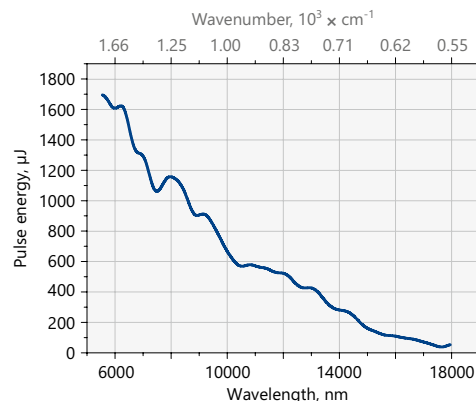

Fig 2. Typical output pulse energy of the NT373-XIR tunable wavelength laser

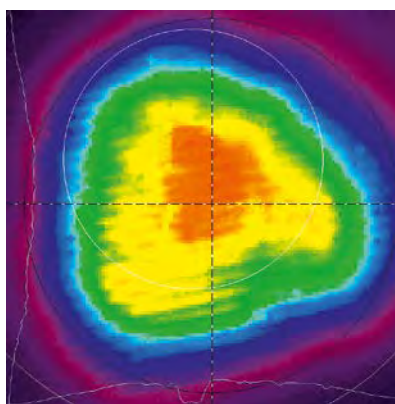

Fig 3. Typical beam profile at 3000 nm and 7000 nm wavelengths in near field

**PHOTO  
TECHNICA** [www.phototechnica.co.jp](http://www.phototechnica.co.jp)  
**フォトテクニカ株式会社**  
 〒336-0017 埼玉県さいたま市南区南浦和 1-2-17  
 TEL:048-871-0067 FAX:048-871-0068  
 e-mail:voc@phototechnica.co.jp