

PHAROS

Modular-Design Femtosecond Lasers for Industry and Science

FEATURES

- 100 fs – 20 ps tunable pulse duration
- 3 mJ maximum pulse energy
- 20 W maximum output power
- Single-shot – 1 MHz repetition rate
- Pulse picker for pulse-on-demand mode
- BiBurst
- Automated harmonic generators (up to 5th harmonic)
- CEP stabilization option
- Repetition rate locking to an external source



PHAROS is a series of femtosecond lasers combining millijoule pulse energy and high average power. PHAROS features a mechanical and optical design optimized for both scientific and industrial applications. A compact, thermally-stabilized, and sealed design enables PHAROS integration into various optical setups and machining workstations. Diode-pumped Yb medium significantly reduces maintenance costs and provides a long laser lifetime, while the robust optomechanical design enables stable operation in varying environments.

The tunability of PHAROS allows the system to cover applications normally requiring multiple different laser systems. Tunable parameters include pulse duration (100 fs – 20 ps), repetition rate (single-shot – 1 MHz), pulse energy (up to 3 mJ), and average power (up to 20 W). A pulse-on-demand mode is available using the built-in pulse picker. The versatility of PHAROS can be extended by a variety of options, including carrier-envelope phase (CEP) stabilization, repetition rate locking to an external source, and automated harmonic modules.

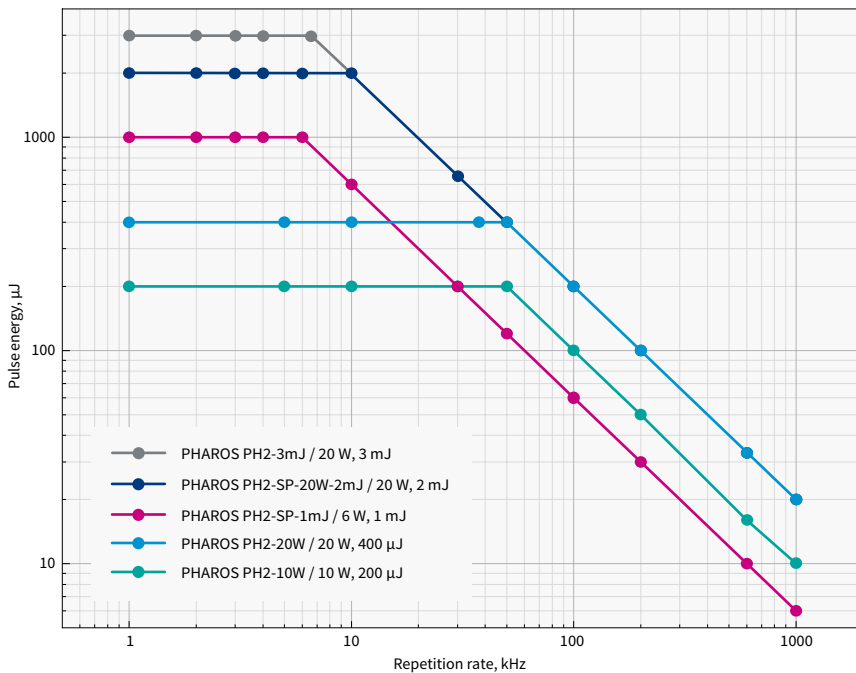

Pulse energy vs fundamental repetition rate of PHAROS

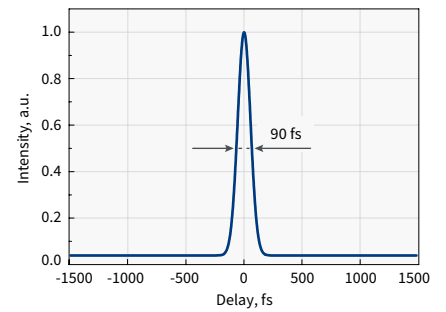

Typical pulse duration of PHAROS-PH2-UP

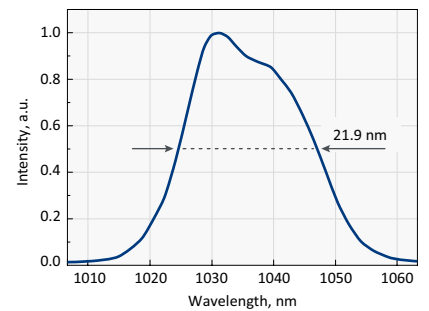

Typical spectrum of PHAROS-PH2-UP

SPECIFICATIONS

Model ¹⁾	PH2-10W	PH2-20W	PH2-3mJ NEW	PH2-1mJ-SP	PH2-2mJ-SP	PH2-UP NEW
---------------------	---------	---------	---	------------	------------	--

OUTPUT CHARACTERISTIC

Maximum output power	10 W	20 W		10 W	20 W	10 W / 20 W
Pulse duration ²⁾	< 290 fs		< 350 fs ³⁾	< 190 fs		< 100 fs
Pulse duration tuning range	290 fs – 10 ps (20 ps on request)		350 fs – 10 ps (20 ps on request)	190 fs – 10 ps (20 ps on request)		100 fs – 10 ps
Maximum pulse energy	0.2 mJ / 0.4 mJ		3 mJ	1 mJ	2 mJ	0.2 mJ / 0.4 mJ
Repetition rate	Single-shot – 1 MHz					
Pulse selection	Single-shot, pulse-on-demand, any fundamental repetition rate division					
Center wavelength ⁴⁾	1030 ± 10 nm					
Polarization	Linear, horizontal					
Beam quality, M ²	< 1.2					
Beam diameter ⁵⁾	3.6 mm / 4.3 mm		7.3 mm	5 mm	7.3 mm	5.2 mm
Beam pointing stability	< 20 μrad/°C					
Pre-pulse contrast	< 1 : 1000					
Post-pulse contrast	< 1 : 200					
Pulse-to-pulse energy stability ⁶⁾	RMS deviation ⁷⁾ < 0.5% over 24 h					
Long-term power stability ⁶⁾	RMS deviation ⁷⁾ < 0.5% over 100 h					

OPTIONAL EXTENSIONS

Oscillator output	Optional. Contact sales@lightcon.com for more details					
Typical output	1 – 6 W, 50 – 250 fs, ≈ 1035 nm, ≈ 76 MHz; available simultaneously					
Harmonic generator	Integrated, optional (see page 8)					
Output wavelength	515 nm, 343 nm, 257 nm, or 206 nm					
Optical parametric amplifier	Integrated, optional (see page 14)					
Tuning range	320 – 10000 nm					
BiBurst option	Tunable GHz and MHz burst with burst-in-burst capability, optional (see page 9)					
GHz-Burst						
Intra burst pulse period ⁸⁾	200 ± 40 ps					
Number of pulses, P ⁹⁾	1 – 25					
MHz-Burst						
Intra burst pulse period	≈ 15 ns					
Number of pulses, N	1 – 9 (7 with FEC)					

PHYSICAL DIMENSIONS

Laser head (L × W × H) ¹⁰⁾	730 × 419 × 230 mm	843 × 492 × 250 mm	730 × 419 × 230 mm
Chiller (L × W × H)	590 × 484 × 267 mm		
24 V DC power supply (L × W × H) ¹⁰⁾	280 × 144 × 49 mm		

ENVIRONMENTAL & UTILITY REQUIREMENTS

Operating temperature	15 – 30 °C (air conditioning recommended)		
Relative humidity	< 80% (non-condensing)		
Electrical requirements	100 V AC, 12 A – 240 V AC, 5 A; 50 – 60 Hz		
Rated power	1000 W		
Power consumption	600 W		
Electrical requirements (chiller)	100 – 230 V AC; 50 – 60 Hz		
Rated power (chiller)	1400 W		
Power consumption (chiller)	1000 W		

¹⁾ More models are available on request.

²⁾ Assuming Gaussian pulse shape.

³⁾ Pulse duration can be reduced to < 250 fs if pulse peak intensity of > 50 GW/cm² is tolerated by customer setup.

⁴⁾ Precise wavelength for specific models are available on request.

⁵⁾ FW 1/e², measured at laser output, using maximum pulse energy.

⁶⁾ Under stable environmental conditions.

⁷⁾ Normalized to average pulse energy, NRMSD.

⁸⁾ Custom spacing is available on request.

⁹⁾ Maximum number of pulses in a burst depends on the laser repetition rate. Custom number of pulses are available on request.

¹⁰⁾ Dimensions depend on laser configuration and integrated options.

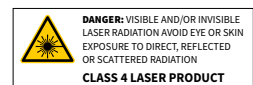

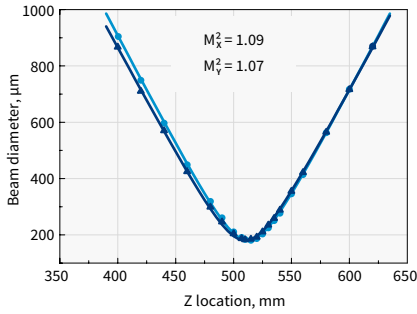

Typical M^2 measurement data of PHAROS

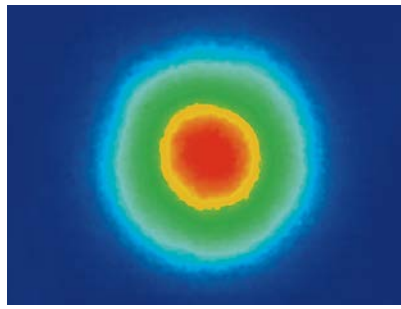

Typical near-field beam profile of PHAROS

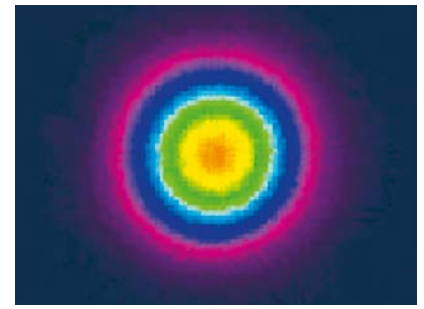

Typical far-field beam profile of PHAROS

STABILITY MEASUREMENTS

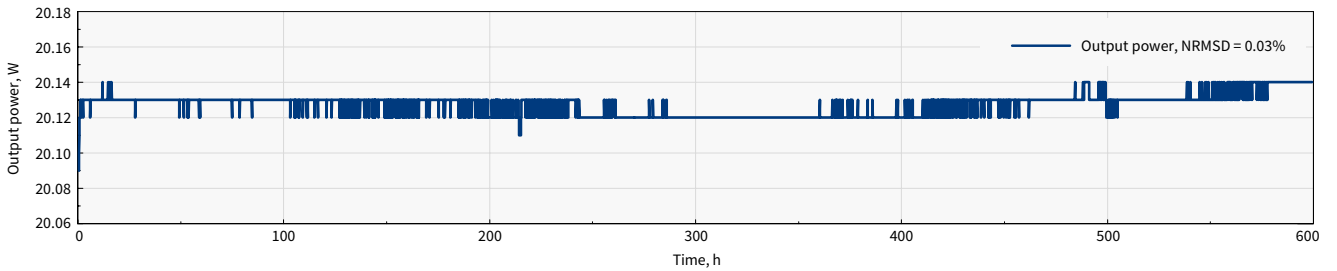

Long-term power stability of PHAROS

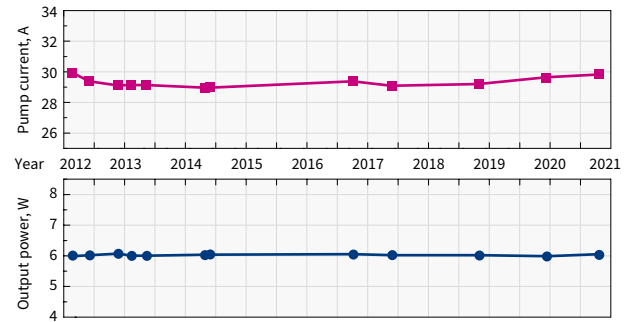
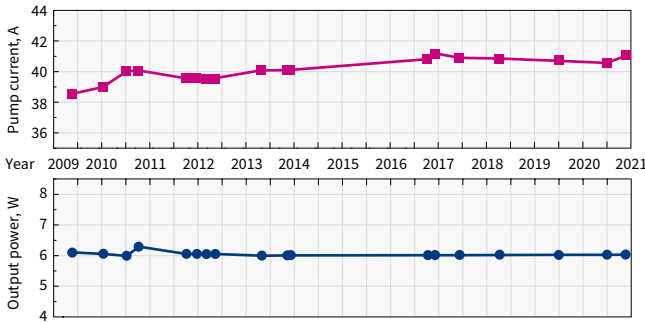

Output power of industrial-grade PHAROS lasers operating 24/7 and current of pump diodes during the years

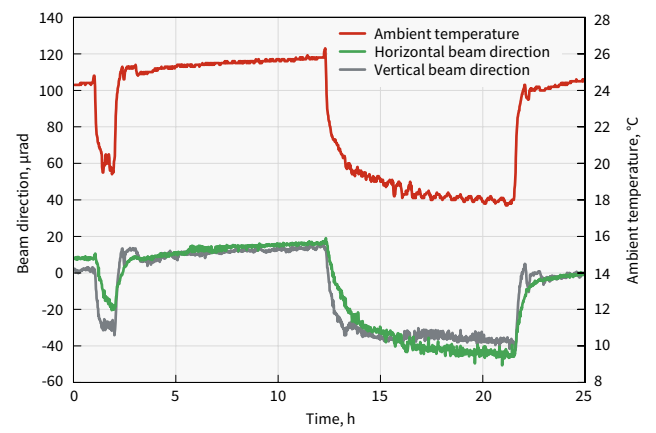
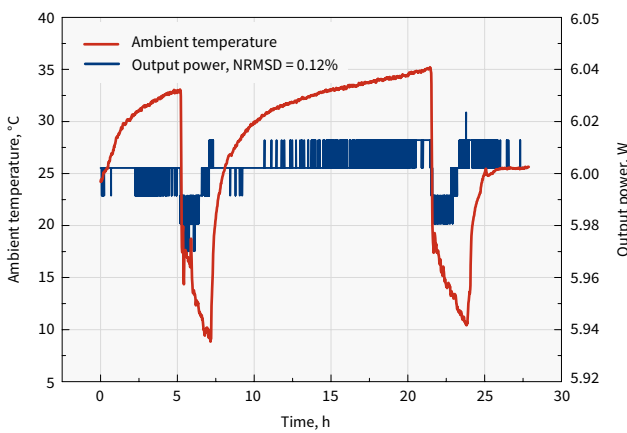

PHAROS output power and beam direction with power lock enabled, under harsh environmental conditions

DRAWINGS

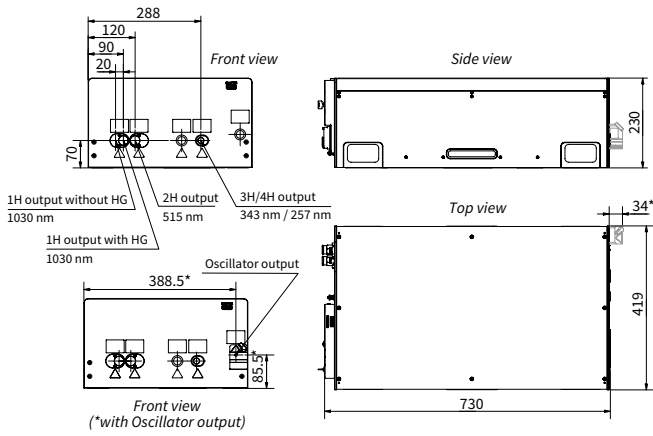

PHAROS-PH2 drawing

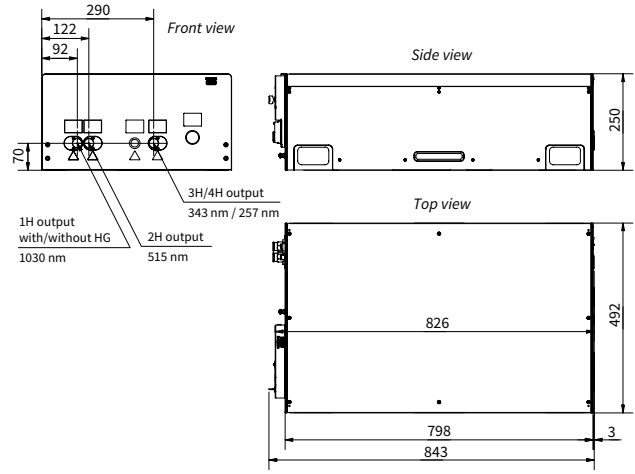

PHAROS-PH2-3mJ drawing

HG | PHAROS

Automated Harmonic Generators

FEATURES

- 515 nm, 343 nm, 257 nm, or 206 nm output
- Automated harmonic selection
- Industrial-grade design



Harmonic generator attached to PHAROS

PHAROS lasers equipped with automated harmonic generators (HGs) provide a selection of fundamental (1030 nm), second (515 nm), third (343 nm), fourth (257 nm), or fifth (206 nm) harmonic outputs using software control.

HGs are perfect for industrial applications that require a single-wavelength output. Modules, mounted directly at the output of the laser, are fully integrated into the system.

SPECIFICATIONS

Model	2H (-HE)	2H-3H (-HE)	2H-4H (-HE)	4H-5H
Output wavelength ¹⁾ (automated selection)	1030 nm 515 nm	1030 nm 515 nm 343 nm	1030 nm 515 nm 257 nm	1030 nm 257 nm 206 nm
Pump pulse energy	20 – 3000 μJ	50 – 3000 μJ	20 – 3000 μJ	200 – 1000 μJ
Pump pulse duration	100 – 500 fs			
Conversion efficiency	> 50% (2H)	> 50% (2H) > 25% (3H)	> 50% (2H) > 10% (4H) ²⁾	> 10% (4H) ²⁾ > 5% (5H) ³⁾
Beam quality (M ²) typical values	≤ 400 μJ pump	< 1.15 (2H) < 1.2 (3H)	< 1.15 (2H) n/a (4H)	n/a
	> 400 μJ pump	< 1.2 (2H) < 1.3 (3H)	< 1.2 (2H) n/a (4H)	

¹⁾ Depends on pump laser model.

²⁾ Maximum output power of 1 W. Please contact sales@lightcon.com for higher power option.

³⁾ Maximum output power of 150 mW.

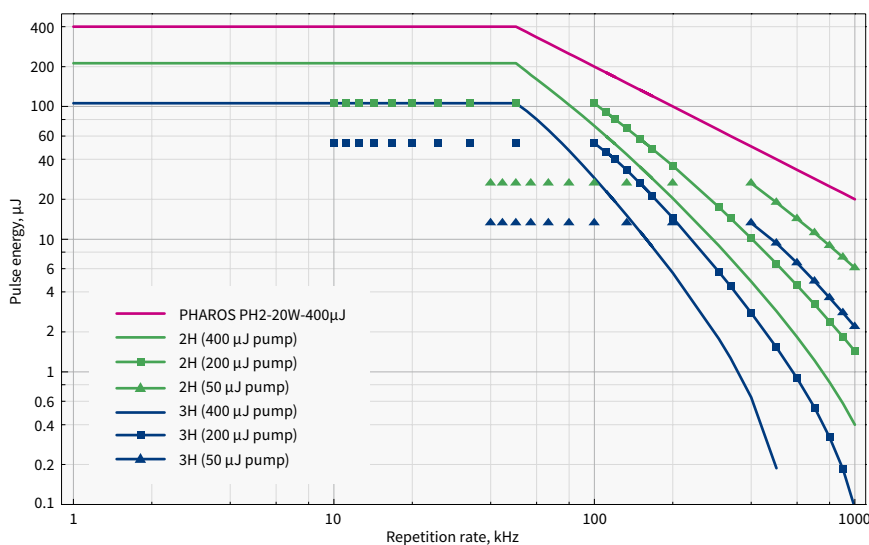
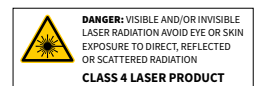

Pulse energy vs repetition rate of PHAROS with HG

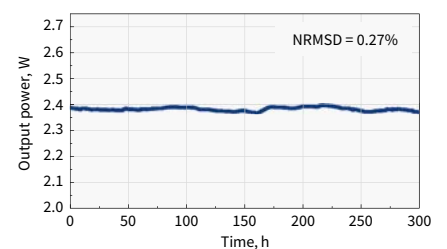

3H output power stability

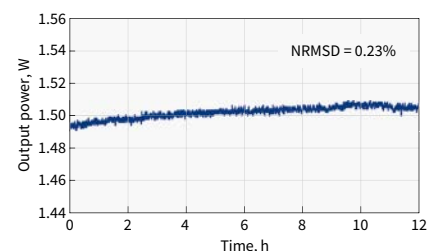

4H output power stability

BiBurst option

Tunable GHz and MHz Burst with Burst-in-Burst Capability

PHAROS and CARBIDE-CB3 lasers have an option for tunable GHz and MHz burst with burst-in-burst capability – called BiBurst.

In standard mode, a single pulse is emitted at some fixed frequency. In burst mode, the output consists of pulse packets instead of single pulses. Each packet consists of a certain number of equally separated pulses. MHz-Burst contains N pulses with a nanosecond period, GHz-Burst contains P pulses with a picosecond period. If both bursts are used, the equally separated pulse packets contain sub-packets of pulses (burst-in-burst, BiBurst).

PHAROS and CARBIDE lasers with the BiBurst option bring new capabilities to high-tech manufacturing industries such as consumer electronics, integrated photonic chip manufacturing, future display manufacturing, and quantum technologies. The applications include:

- brittle material drilling and cutting
- deep engraving
- selective ablation
- volume modification of transparent materials
- hidden marking
- surface polishing
- surface functionalization

SPECIFICATIONS

Model		CARBIDE-CB3	PHAROS
GHz Burst	Intra burst pulse period ¹⁾	440 ± 40 ps	200 ± 40 ps
	Number of pulses, P ²⁾	1 – 10	1 – 25
MHz Burst	Intra burst pulse period	≈ 15 ns	
	Number of pulses, N	1 – 10	1 – 9 (7 with FEC)

¹⁾ Custom spacing is available on request.

²⁾ Maximum number of pulses in a burst depends on the laser repetition rate. Custom number of pulses is available on request.

