

LightWire FFS series

Compact
Fiber Seeders for
Femtosecond Lasers



FEATURES

- ▶ Pulse energy > 250 nJ at repetition rate < 200 kHz
- ▶ Compressed or chirped broadband pulses
- ▶ Down to 300 fs pulses available after compression (for FFS100CHI and FFS200CHI)
- ▶ Pulse duration < 130 fs (for FFS200)

APPLICATIONS

- ▶ Seeding femtosecond CPA systems
- ▶ Ultrafast spectroscopy
- ▶ Time-domain terahertz spectroscopy

LightWire FFS series fiber lasers are dedicated for seeding solid state femtosecond Yb:YAG based CPA systems. Ekspla offers FFS lasers either with femtosecond pulse duration directly from fiber, or with chirped pulses. Broad up to 12 nm spectral

bandwidth enables amplification of pulses with < 300 fs compressed duration. Special feature of FFS200CHI laser is customizable chirp profile to match compressor design of the CPA system.

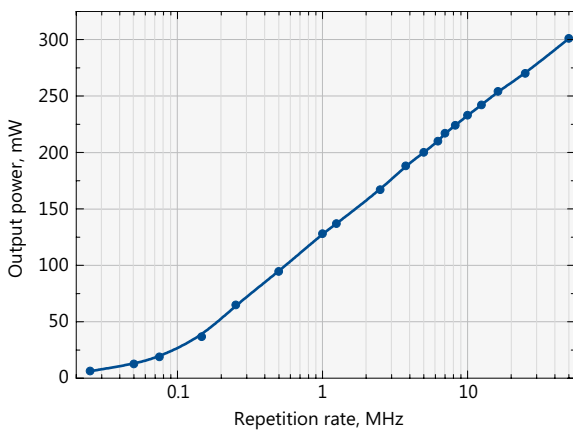

Typical dependence of average power on the repetition rate for FFS200CHI laser

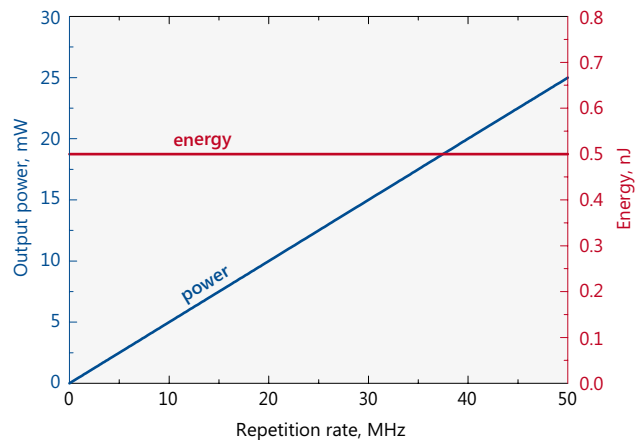

Typical dependence of average power (blue curve) and pulse energy (red curve) on the repetition rate for FFS100CHI-AOM laser

SPECIFICATIONS ¹⁾

Model	FFS100CHI	FFS200CHI	FFS200
Central wavelength	1030 ± 1 nm		1064 nm
Spectral bandwidth	8 ± 1 nm	up to 12 nm	30 nm (typical)
Pulse duration from the laser	7 ± 2 ps (chirped)	> 50 ps (chirped)	< 130 fs
Compressed pulse duration	< 300 fs	down to 300 fs	NA
Chirp profile	linear	custom ²⁾	NA
Oscillator pulse repetition rate	50 ± 3 MHz		40 ± 2 MHz
Pulse repetition rate with pulse picker ³⁾	25 kHz – 50 MHz (PRR = PRR _{osc} / N, N = 1, 5, 6, ..., 2000)	200 kHz – 50 MHz (PRR = PRR _{osc} / N, N = 1, 5, 6, ..., 2000)	20 kHz – 40 MHz (PRR = PRR _{osc} / N, N = 1, 4, 5, ..., 2000)
Output power (without/with pulse picker)	> 50 mW / > 25 mW	> 200 mW at 10 MHz > 100 mW at 1 MHz > 25 mW at 100 kHz	> 200 mW / > 100 mW
Pulse energy (without/with pulse picker)	> 1 nJ / > 0.5 nJ	> 250 nJ at repetition rates < 200 kHz	> 5 nJ / > 2.5 nJ
Polarization	linear, > 100:1 extinction		linear, > 10:1 extinction
Optical output	FC/APC connector or collimator with mounting flange (optional)	collimator & isolator node ⁴⁾	FC/PC connector ⁵⁾ or collimated beam (optional)
Output fiber length	up to 5 m	up to 3 m	up to 1.4 m
Beam diameter	0.9 ± 0.1 mm or 1.3 ± 0.1 mm or 2.1 ± 0.2 mm	0.9 ± 0.1 mm	2 ± 0.2 mm
Beam height	NA	38 mm	NA
Beam quality	M ² < 1.1		M ² < 1.5
Pulse train monitoring	photodiode output for oscillator train, TTL synch pulse for laser output (when pulse picker included)		
Dimensions of collimator (D × L)	Ø33.02 × 11.76 mm		
Control interface	USB, CAN, RS232, LAN, (WLAN optional)		
Power supply (AC/DC adapter included)	100–240 V, 50–60 Hz AC		
Power consumption	maximal 230 W (typical 60 W)		
Operating conditions	10–30 °C, humidity – not condensing		

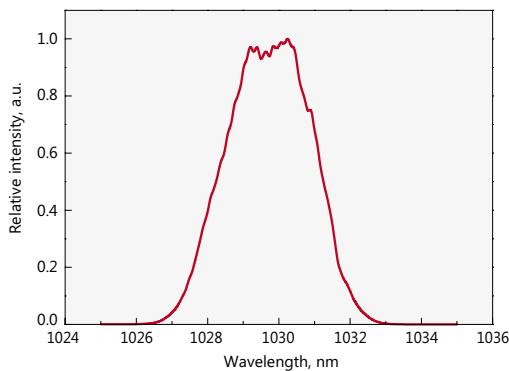

Typical spectrum from FFS200CHI laser

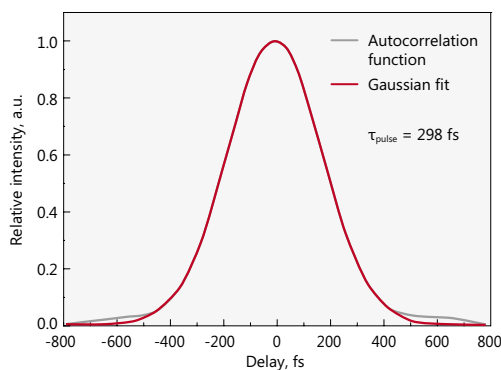

Typical FFS100CHI compressed pulse autocorrelation

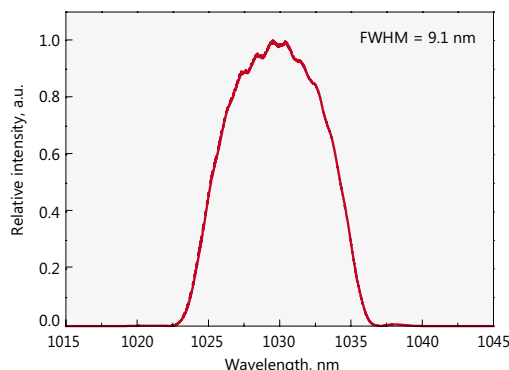

Typical spectrum from FFS100CHI laser

- ¹⁾ Due to continuous improvement all specifications are subject to change without notice.
- ²⁾ Chirp profile will be optimized by Ekspla to match customer compressor design.
- ³⁾ Pulse picker is an option for FFS100 and FFS200 models. It supports external gating. FFS200CHI includes internal frequency divider, which enables pulse repetition rate reduction but does not support external gating.
- ⁴⁾ FFS200CHI model is provided with collimator & isolator node with dimensions 138×66.6×52 mm.
- ⁵⁾ The connector is not suitable to connect with single mode fiber.



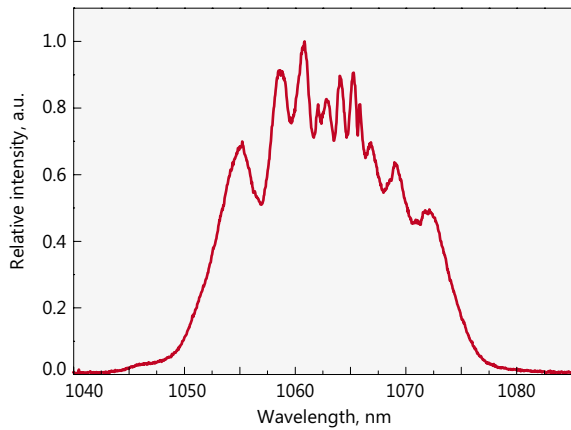

Typical spectrum from FFS200 laser

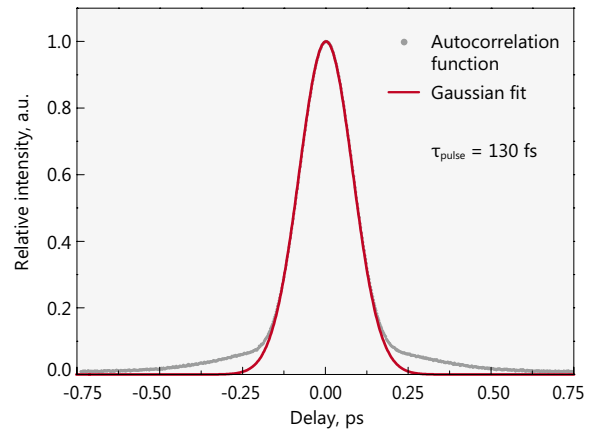

Typical autocorrelation from FFS200 laser

DRAWINGS

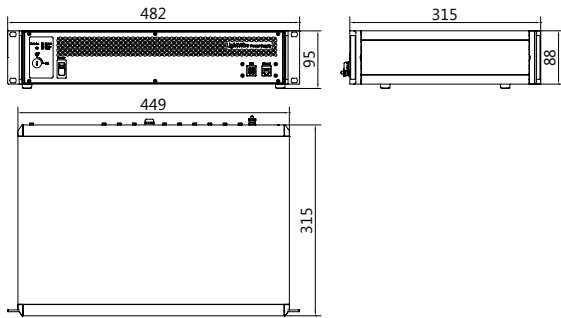

LightWire FFS series control unit outline drawing (19" rack mountable version)

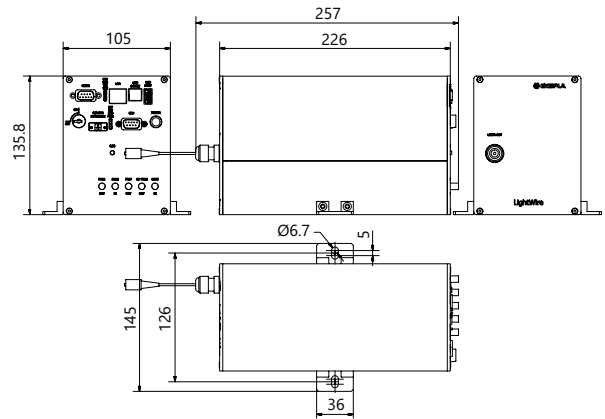

LightWire FFS series "Compact" version drawing. Example only. Actual dimensions depends on a selected laser configuration and options. Please enquire

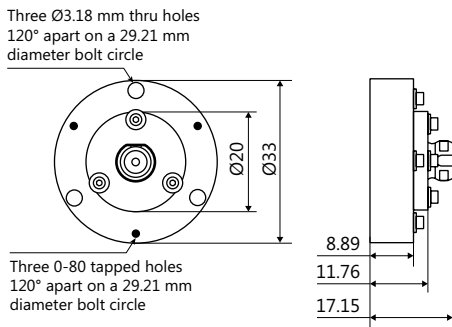

LightWire FFS100CHI laser collimator flange outline drawing for beam diameters 0.9 mm and 1.3 mm

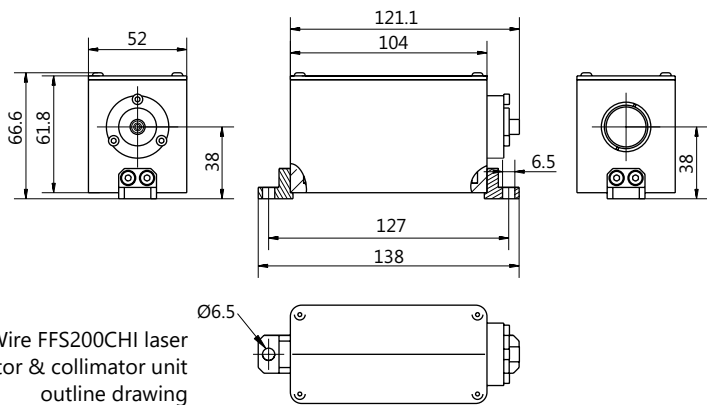

LightWire FFS200CHI laser isolator & collimator unit outline drawing

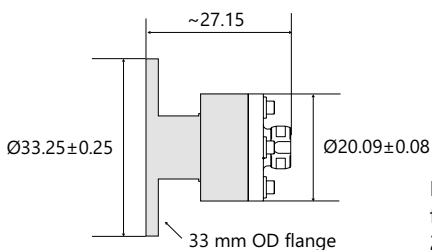

LightWire FFS100CHI/200 laser collimator flange outline drawing for beam diameter 2.1/2.0 mm

All dimensions are in millimetres.