

# FLINT

## High-Repetition-Rate Lasers

### FEATURES

- 11, 40, or 76 MHz repetition rate
- Down to 50 fs pulse duration
- High-power models, up to 20 W
- High-energy energy models, up to 0.6  $\mu\text{J}$
- Industrial-grade design for high output stability
- CEP stabilization or repetition rate locking



FLINT-FL1

FLINT is a series of Yb-based femtosecond oscillators providing state-of-the-art output parameters. Backed by the proven industrial-grade design that is the core of the PHAROS and CARBIDE laser series, FLINT oscillators ensure excellent performance and stability over a long time.

The latest FLINT-FL2 oscillators offer output power of up to 20 W, pulse energy of up to 0.6  $\mu\text{J}$ , and pulse duration of down to 50 fs at the repetition rate of 11, 40, or 76 MHz. Also, the second harmonic is available with an automated and fully

integrated harmonic generator, while the third and fourth harmonic is obtainable with an external harmonic generator. The FLINT-FL1 oscillators support carrier-envelope phase (CEP) stabilization or repetition rate locking (RRL) to an external source with the repetition rate selection from 60 to 100 MHz. FLINT models come in standard and short-pulse (SP) configurations to fit the needs of most industrial and scientific applications.

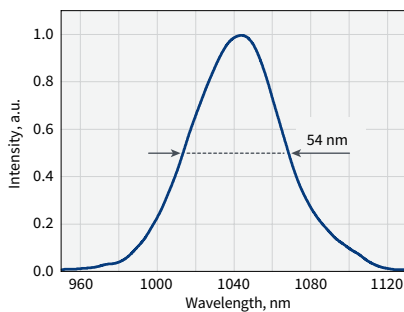

Typical spectrum of FLINT-FL2-SP

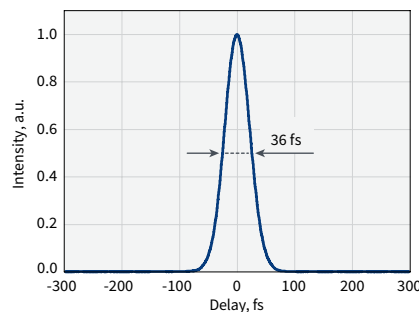

Typical pulse duration of FLINT-FL2-SP

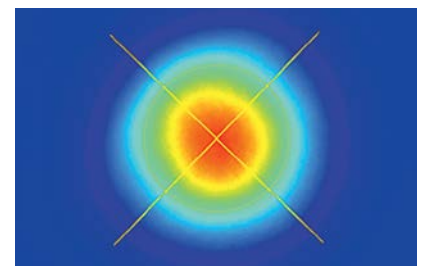

Typical beam profile of FLINT-FL2-SP

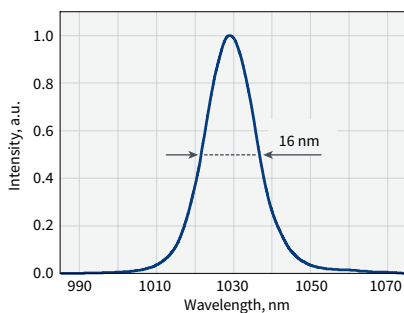

Typical spectrum of FLINT-FL1

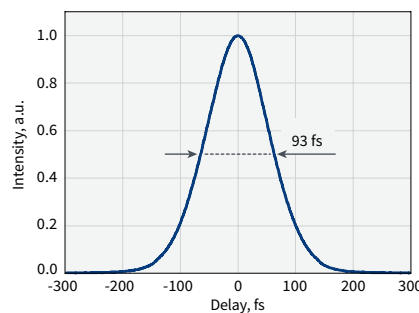

Typical pulse duration of FLINT-FL1

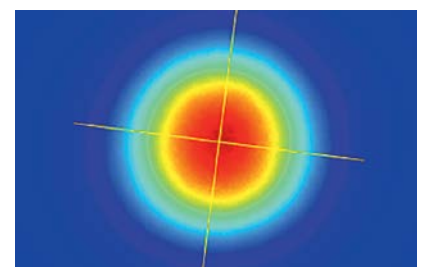

Typical beam profile of FLINT-FL1

## SPECIFICATIONS

Model	FL1			FL2-SP			FL2		
Key feature	CEP	RRL	Compact	Short pulse			High power and high energy		
Pulse duration	< 100 fs		< 120 fs	< 50 fs			< 120 fs	< 170 fs <sup>1)</sup>	
Repetition rate	60 – 100 MHz <sup>2)</sup>			11 MHz	40 MHz	76 MHz	11 MHz	40 MHz	76 MHz
Maximum output power	0.5 W	1 W	8 W	5 W			7 W	20 W	
Maximum pulse energy	6.5 nJ <sup>3)</sup>	13 nJ <sup>3)</sup>	105 nJ <sup>3)</sup>	440 nJ	125 nJ	65 nJ	0.6 μJ	0.5 μJ	0.26 μJ
Center wavelength	1035 ± 10 nm			1035 ± 10 nm			1030 ± 10 nm		
Polarization	Linear, horizontal								
Beam quality, M <sup>2</sup>	< 1.2			< 1.3			< 1.2		
Beam pointing stability	< 10 μrad/°C								
Pulse-to-pulse energy stability, 24 h <sup>4)</sup>	< 0.5%								
Long-term power stability, 100 h <sup>4)</sup>	< 0.5%								
Integrated 2H generator <sup>5)</sup>	n/a						Optional; conversion efficiency > 30% <sup>6)</sup> ; see page 21		
External 2H, 3H, or 4H generator <sup>5)</sup>	Optional, refer to HIRO for FLINT; see page 25								
Integrated attenuator	n/a			Included					

## PHYSICAL DIMENSIONS

Laser head (L × W × H)	430 × 197 × 114 mm	542 × 322 × 146 mm
Power supply and chiller rack (L × W × H)	642 × 553 × 540 mm	642 × 553 × 673 mm
Chiller	Different options available. Contact sales@lightcon.com	

## ENVIRONMENTAL AND UTILITY REQUIREMENTS

Operating temperature	15 – 30 °C (air conditioning recommended)	
Relative humidity	< 80% (non-condensing)	
Electrical requirements	100 V AC, 7 A – 240 V AC, 3 A; 50 – 60 Hz	100 V AC, 12 A – 240 V AC, 5 A; 50 – 60 Hz
Rated power	200 W	
Power consumption	Laser: 100 W; chiller: 600 W	Laser: 150 W; chiller: 1000 W

<sup>1)</sup> For 20 W output power, lower power models, 8 W and 12 W, available upon request.

<sup>2)</sup> Standard repetition rate is 76 MHz; custom repetition rate can be factory preset from the given range.

<sup>3)</sup> Depends on the repetition rate. Values are given for 76 MHz.

<sup>4)</sup> With enabled power-lock, under stable environmental conditions. Expressed as NRMSD (normalized root mean squared deviation).

<sup>5)</sup> For external 2H, or even 3H and 4H generation, refer to HIRO for FLINT.

<sup>6)</sup> Conversion efficiency specified at maximum power.

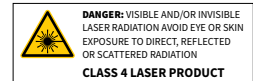

## STABILITY

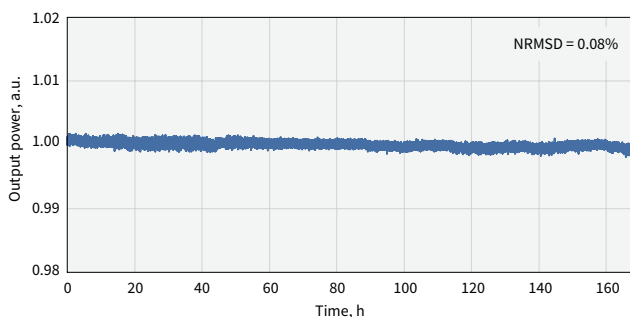

FLINT-FL2 (20W) output power stability under harsh environmental conditions over 7 days

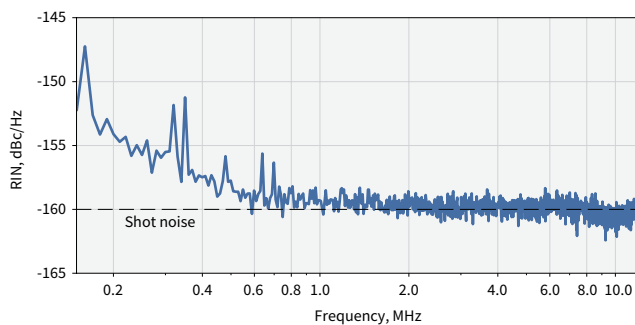

Relative intensity noise (RIN) of FLINT oscillator, shot-noise limited at -160 dBc/Hz above 1 MHz

## CEP STABILIZATION

FLINT oscillators can be equipped with feedback electronics for carrier-envelope phase (CEP) stabilization of the output pulses. The carrier-envelope offset (CEO) of the oscillator is actively locked to 1/4<sup>th</sup> of the repetition rate with a <100 mrad standard deviation.

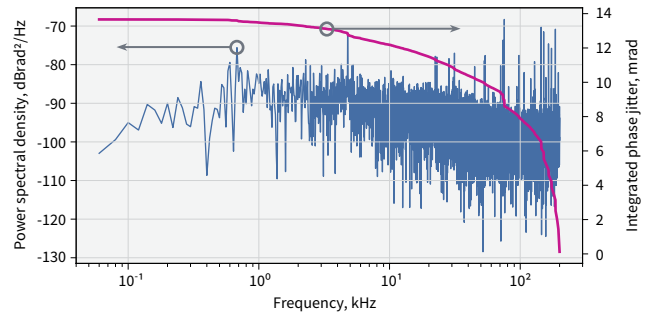

Phase noise data of CEP locked FLINT oscillator

## REPETITION RATE LOCKING

FLINT oscillators are customizable for repetition rate locking applications. Coupled with the necessary feedback electronics, the repetition rate can be synchronized to an external RF source using the two piezo stages installed inside the cavity.

The repetition rate locking system can assure an integrated timing jitter of less than 200 fs for RF reference frequencies larger than 500 MHz. Continuous phase shifting is available on request.

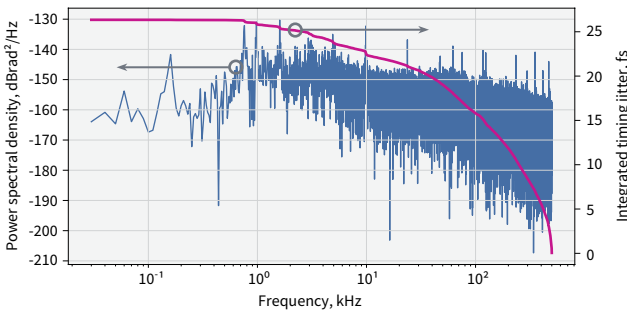

Phase noise data of FLINT oscillator locked to a 2.8 GHz RF source

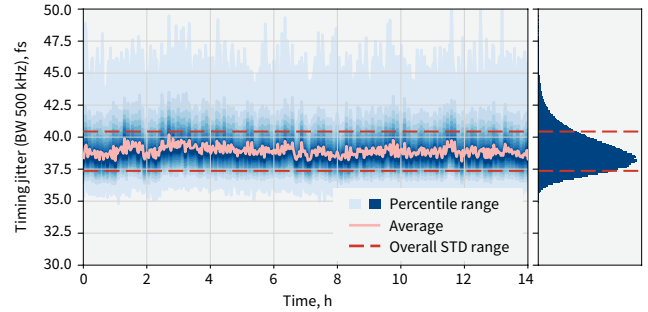

Timing jitter stability over 14 h; FLINT oscillator locked to a 2.8 GHz RF source

## DRAWINGS

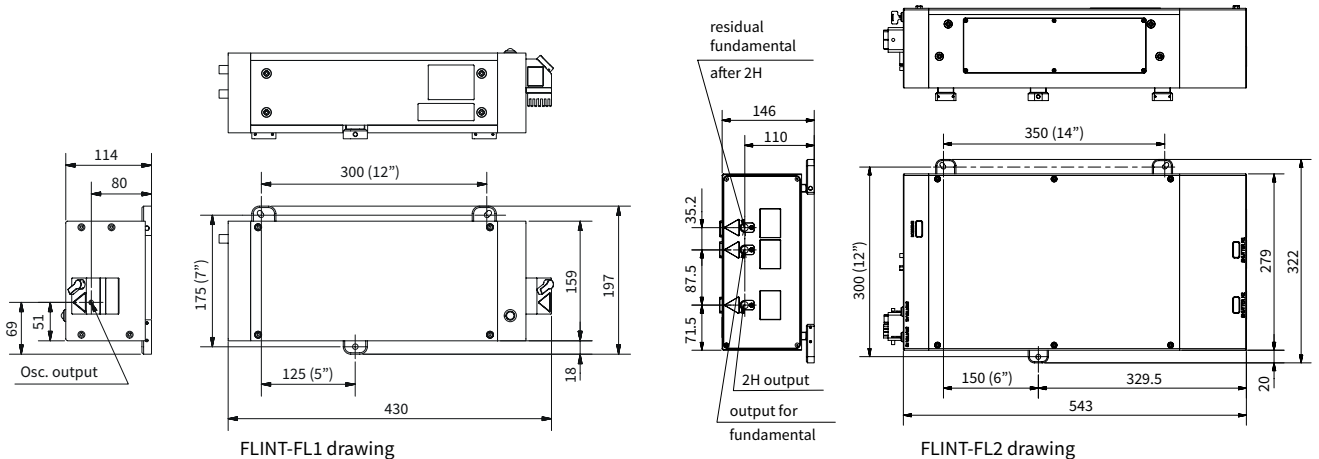

**PHOTO  
TECHNICA** www.phototechnica.co.jp  
 フォトテクニカ株式会社  
 〒336-0017 埼玉県さいたま市南区南浦和 1-2-17  
 TEL:048-871-0067 FAX:048-871-0068  
 e-mail:voc@phototechnica.co.jp

# HG | FLINT

## Automated Second Harmonic Generator

### FEATURES

- 515 nm output
- Automated harmonic selection
- Integrated into the system
- Industrial-grade design



FLINT-FL2 with integrated HG

FLINT oscillators equipped with an automated second harmonic generator (HG) provide a selection of fundamental (1H) or second harmonic (2H) outputs using software control. The HG is fully integrated into the industrial-grade system.

Fundamental and second harmonic outputs are switchable or available simultaneously. For higher harmonics, refer to HIRO harmonic generator.

### SPECIFICATIONS

Model	FL1	FL2-SP	FL2			
Available harmonic	Refer to HIRO; see page 25		2H			
Pump repetition rate			11 MHz	40 MHz	76 MHz	
Maximum pump power			7 W	20 W		
Center wavelength			515 ± 10 nm			
Conversion efficiency <sup>1)</sup>			> 30%			
Polarization			Linear, horizontal			

<sup>1)</sup> Conversion efficiency specified at maximum power.

