

High-Repetition-Rate Femtosecond Lasers

High-power models, up to 20 W

High-energy models, up to 0.5 μJ

10 – 90 MHz repetition rate

Down to 50 fs pulse duration

CEP stabilization or repetition rate locking



FLINT-FL1

FLINT-FL1
Typical spectrum

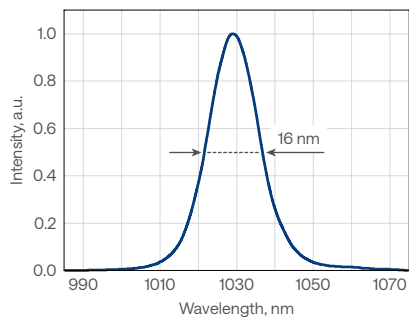

FLINT-FL1
Typical pulse duration

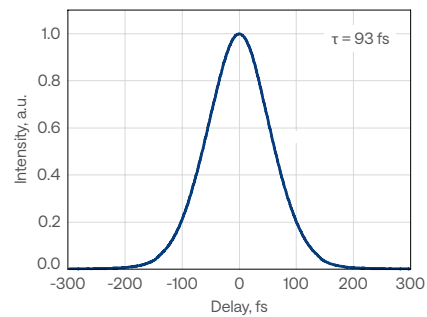

FLINT-FL1
Typical beam profile

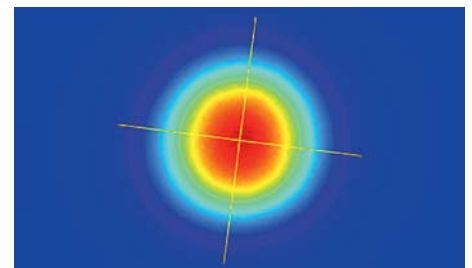

FLINT-FL2 (20 W) output power stability under harsh environmental conditions over 7 days

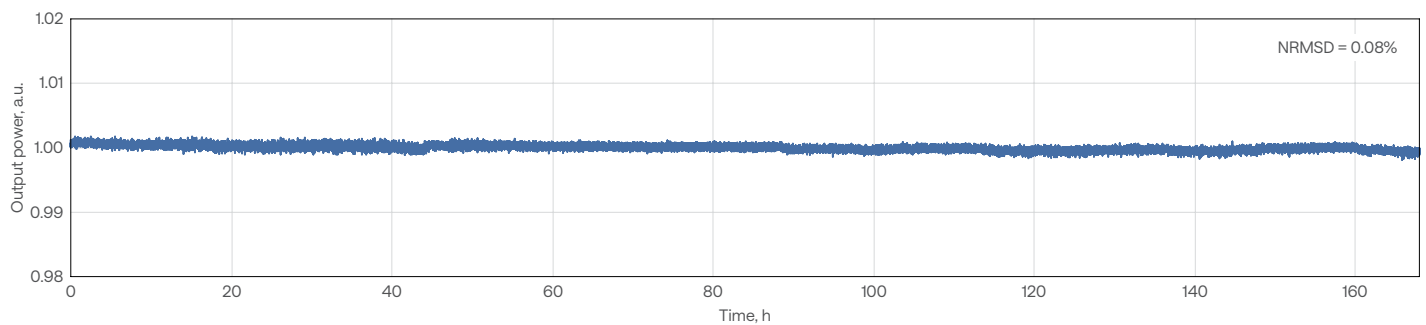

Specifications

Model	FL1			FL2-SP	FL2	
Key feature	CEP	RRL	Compact	Short pulse	High power and high energy	
Pulse duration	< 100 fs		< 120 fs	< 50 fs	< 120 fs	< 170 fs ¹⁾
Repetition rate	60 – 90 MHz ²⁾			10 MHz	10 MHz	40 MHz 80 MHz
Maximum output power	0.5 W	1 W	8 W	4 W	5 W	20 W
Maximum pulse energy	6 nJ ³⁾	12.5 nJ ³⁾	100 nJ ³⁾	0.4 μJ	0.5 μJ	0.25 μJ
Center wavelength	1035 ± 10 nm			1030 ± 10 nm	1030 ± 10 nm	
Polarization	Linear, horizontal					
Beam quality, M ²	< 1.2			< 1.3	< 1.2	
Beam pointing stability	< 10 μrad/°C					
Long-term power stability, 100 h ⁴⁾	< 0.5%					
Integrated 2H generator ⁵⁾	n/a			Optional; conversion efficiency > 30% ⁶⁾ refer to FLINT HG		
External 2H, 3H, or 4H generator	Optional; refer to HIRO					
Integrated attenuator	n/a			Included		

PHYSICAL DIMENSIONS

Laser head (L × W × H)	448 × 206 × 115 mm	543 × 322 × 146 mm
Power supply and chiller rack (L × W × H)	642 × 553 × 540 mm	642 × 553 × 673 mm
Chiller	Different options available. Contact sales@lightcon.com	

ENVIRONMENTAL AND UTILITY REQUIREMENTS

Operating temperature	15 – 30 °C (air conditioning recommended)	
Relative humidity	< 80% (non-condensing)	
Electrical requirements	100 V AC, 7 A – 240 V AC, 3 A; 50 – 60 Hz	100 V AC, 12 A – 240 V AC, 5 A; 50 – 60 Hz
Rated power	200 W	
Power consumption	Laser	100 W
	Chiller	600 W
		150 W
		1000 W

- ¹⁾ For 20 W output power. Lower power models: 8 W and 12 W, are available upon request.
- ²⁾ Standard repetition rate is 80 MHz; custom repetition rate can be factory preset from the given range.
- ³⁾ Depends on the repetition rate. Values are given for 80 MHz.

- ⁴⁾ With enabled power-lock, under stable environmental conditions. Expressed as normalized root mean squared deviation (NRMSD).
- ⁵⁾ For external 2H, or even 3H and 4H generation, refer to HIRO for FLINT.
- ⁶⁾ Conversion efficiency specified at maximum power.

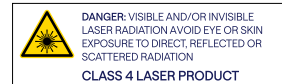

FLINT oscillator relative intensity noise (RIN), shot-noise limited at -160 dBc/Hz above 1 MHz

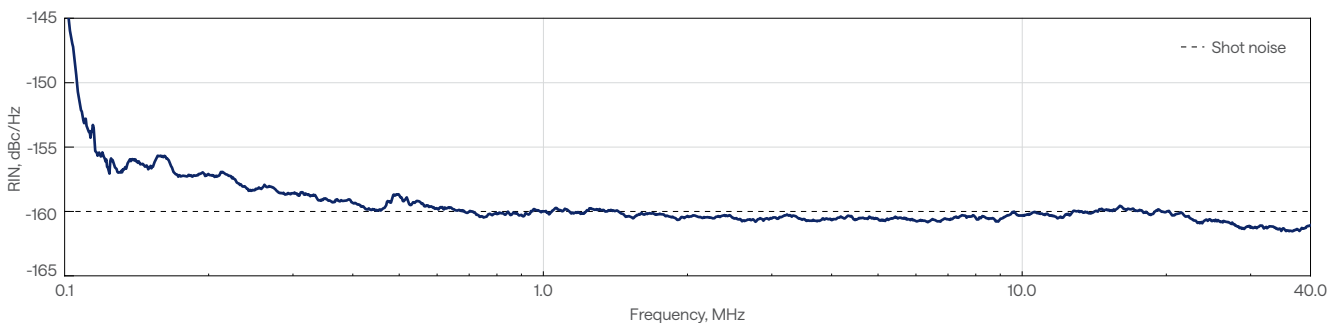

CEP stabilization

FLINT oscillators can be equipped with feedback electronics for carrier-envelope phase (CEP) stabilization of the output pulses. The carrier-envelope offset (CEO) of the oscillator is actively locked to $1/4^{\text{th}}$ of the repetition rate with a < 100 mrad standard deviation.

CEP-locked FLINT oscillator phase noise data

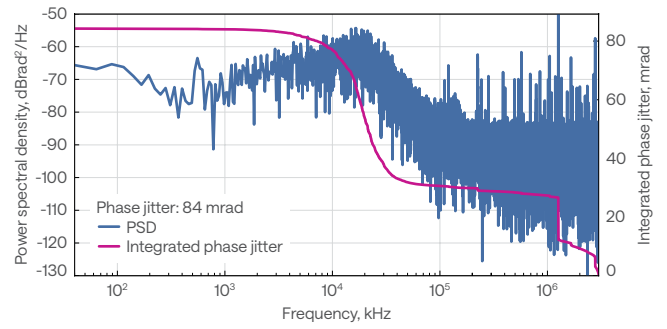

Repetition rate locking

FLINT oscillators can be customized for repetition rate locking applications. Coupled with the necessary feedback electronics, the oscillator's repetition rate can be synchronized to an external RF source using the two piezo stages installed within the cavity.

The repetition rate locking system ensures an integrated timing jitter of less than 200 fs for RF reference frequencies above 500 MHz. Additionally, continuous phase shifting is available upon request.

FLINT oscillator phase noise data locked to a 2.8 GHz RF source

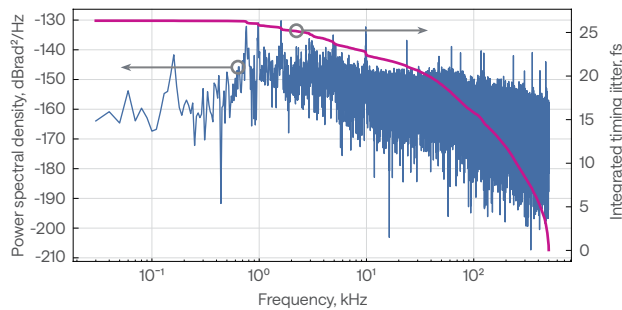

Timing jitter stability over 14 h FLINT oscillator locked to a 2.8 GHz RF source

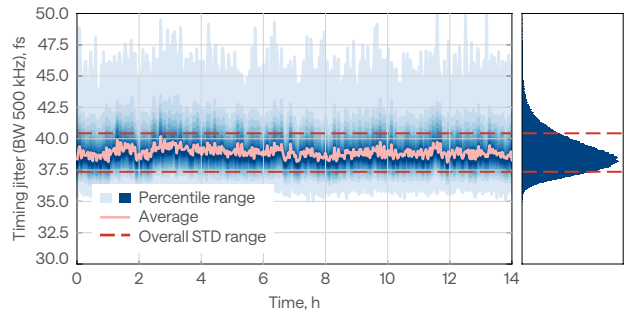

Drawings

FLINT-FL1

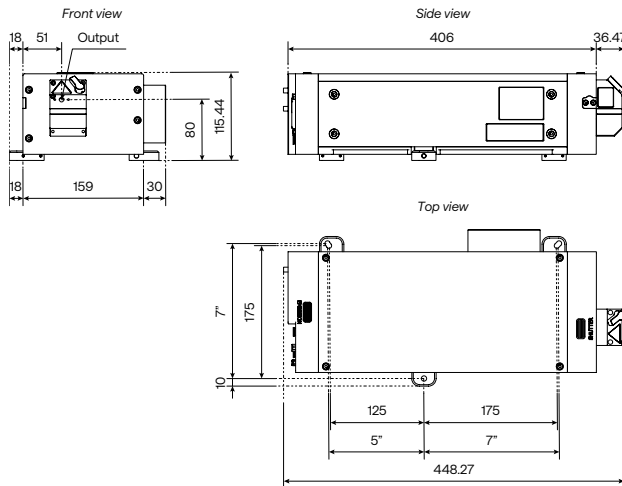

FLINT-FL2

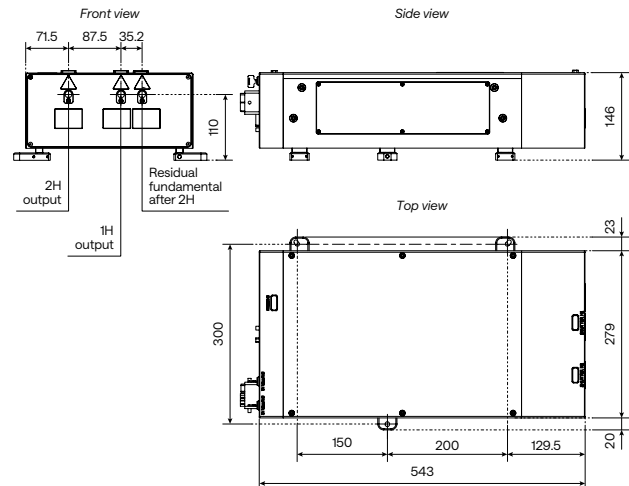

Second Harmonic Generator

515 nm output

Automated harmonic selection

Integrated into the housing

Industrial-grade design



FLINT-FL2 with an integrated harmonic generator

Specifications

Model	FL1	FL2-SP	FL2					
Available harmonic	Refer to HIRO			2H ¹⁾				
Pump repetition rate				10 MHz	40 MHz	80 MHz		
Maximum pump power				5 W	20 W			
Center wavelength				515 ± 10 nm				
Conversion efficiency ²⁾				> 30%				
Polarization				Linear, horizontal				

¹⁾ For external 2H or even 3H and 4H generation, refer to HIRO for FLINT.

²⁾ Conversion efficiency specified at maximum power.

